

---

# User's Guide

Publication Number 54657-97010  
October 1996 (pdf version Dec 1998)

For Safety information, Warranties, and Regulatory information, see the pages behind the index

© Copyright Hewlett-Packard Company 1992-1996  
All Rights Reserved

---

**HP 54657A, HP 54658A,  
and HP 54659B  
Measurement/Storage Modules**

---

# Measurement/Storage Modules

The HP 54657A, HP 54658A, and HP 54659B Measurement/Storage Modules provide additional measurement and storage capabilities to the HP 54600-Series oscilloscopes. The HP 54657A has an HP-IB interface and the HP 54658A has a RS-232 interface. The HP 54659B has a RS-232 interface plus an additional parallel output connector which allows the module to be connected to both an RS-232 controller and a parallel printer at the same time. The main features are:

- Full Programmability.
- Hardcopy output.
- Three additional automatic voltage measurements (amplitude, preshoot, and overshoot).
- Two additional automatic time measurements (delay and phase angle). User defined measurement thresholds of 10%/90%, 20%/80%, or selected voltage levels.
- Two additional cursor measurements (voltage in percent and time in degrees).
- Two additional cursor measurement sources (math function 1 and 2).
- Waveform math functions (addition, subtraction, multiplication, differentiation, integration, and FFT)
- Time and date tagging of hard copy and nonvolatile memories. Three uncompressed nonvolatile trace memories.
- Additional 64K of nonvolatile trace memory (with data compression) for up to 97 more trace memories..
- Unattended waveform monitoring by use of mask templates.
- Built-in automatic mask generation and mask editing capabilities.

### **Accessories available**

- HP 34810B BenchLink/Scope software package.
- HP 10833A 1 meter (3.3 feet) HP-IB cable.
- HP 10833B 2 meter (6.6 feet) HP-IB cable.
- HP 10833C 4 meter (13.2 feet) HP-IB cable.
- HP 10833D 0.5 meter (1.6 feet) HP-IB cable.
- HP 13242G 5 meter (16.7 feet) RS-232 cable for printer/plotter and HP Vectra 25-pin serial port.
- HP 17255M 1.2 meter (3.9 feet) RS-232 cable for printer/plotter and HP Vectra 25-pin serial port.
- HP 17255D 1.2 meter (3.9 feet) RS-232 cable for IBM PC/XT 25-pin serial port.
- HP 92219J 5 meter (16.7 feet) RS-232 cable for IBM PC/XT 25-pin serial port.
- HP 24542G 3 meter (9.9 feet) RS-232 cable for 9-pin serial port.
- HP 34398A 2.5 meter (8.2 feet) RS-232 cable.
- HP 34399A RS-232 Adapter Kit.

---

## In This Book

This book is the user's guide for the HP 54657A, HP 54658A, and HP 54659B Measurement/Storage Modules, and contains **three** chapters.

**Installation** Chapter 1 contains information concerning installation and interconnection of the Measurement/ Storage Modules.

**Operating the Measurement/Storage Module** Chapter 2 contains a series of exercises that guide you through the operation of the Measurement/Storage Modules.

**Reference Information** Chapter 3 lists the reference information concerning the Measurement/Storage Modules.

<b>1</b>	<b>Installation</b>	
<b>2</b>	<b>Operating the Measurement/ Storage Module</b>	
<b>3</b>	<b>Reference Information</b>	
	<b>Index</b>	



---

# Contents

## 1 Installation

- Oscilloscope Compatibility 1-2
- To install the Measurement/Storage Module 1-3
- To configure the interface 1-4

## 2 Operating the Measurement/Storage Module

- Math Functions 2-3
  - Function 1 2-4
  - Function 2 2-5
- FFT Measurement 2-8
- Automatic Measurements 2-14
  - Setting Thresholds 2-15
    - To make delay measurements automatically 2-19
    - To make phase measurements automatically 2-21
    - To make additional voltage measurements automatically 2-23
  - To make additional cursor measurements 2-25
- Unattended Waveform Monitoring 2-29
  - To create a mask template using Automask 2-30
  - To create a mask template using Autostore 2-31
  - To create or edit a mask using line segments 2-33
  - To edit an individual pixel of a mask 2-35
  - To edit the mask to test only a portion of a waveform 2-36
  - To start waveform monitoring 2-38
  - To automatically save test violations 2-40
- Creating a delay testing mask 2-42
- Creating a frequency testing mask 2-44
- Creating an overshoot testing mask 2-46
- Creating a rise time testing mask 2-48
- Testing the eye opening of an eye-pattern signal 2-50
  - To save or recall traces 2-52
  - To create a label for a trace memory 2-54
  - To set real-time clock 2-55

**3 Reference Information**

Operating Characteristics 3-3

**Index**





Installation

---

# Installation

This chapter provides you with the information necessary to install the Measurement/Storage Module on the oscilloscope. Information required to connect and configure the module to the desired external devices (such as printer, plotter, computer) prior to local or remote operation is given in the *Interface Modules for HP 54600-Series Instruments I/O Function Guide* shipped with your module.

---

## Oscilloscope Compatibility

**HP 54657A and HP 54658A** These modules are compatible with all HP 54600-series oscilloscopes except HP 54600A, HP 54601A, and HP 54602A oscilloscopes with an operating system version lower than 2.2. If your 54600A, HP 54601A, or HP 54602A oscilloscope has an earlier operating system, it can be updated using upgrade kit HP part number 54601-68702. The version is briefly displayed on screen when the **Print/Utility** key is pressed.

**HP 54659B** The HP 54659B is **NOT** compatible with the HP 54600A, HP 54601A, HP 54602A, or HP 54610A Oscilloscope. This module is compatible with all other HP 54600-series oscilloscopes with an operating system version 1.2 or higher or with an operating system version number in the form of A.XX.XX. If your HP 54600B, HP 54601B, HP 54602B, or HP 54603B Oscilloscope has an earlier operating system, it can be updated using upgrade kit HP part number 54601-68704. If your 54610B Oscilloscope has an earlier operating system, it can be updated using upgrade kit HP part number 54610-68704. The version number is briefly displayed on screen when the **Print/Utility** key is pressed.

---

## To install the Measurement/Storage Module

- 1 Turn off the oscilloscope.
- 2 Install the module as shown below.

The oscilloscope is reset after installation. The installed module is reflected in the message displayed when you turn on the oscilloscope.

Figure 1-1

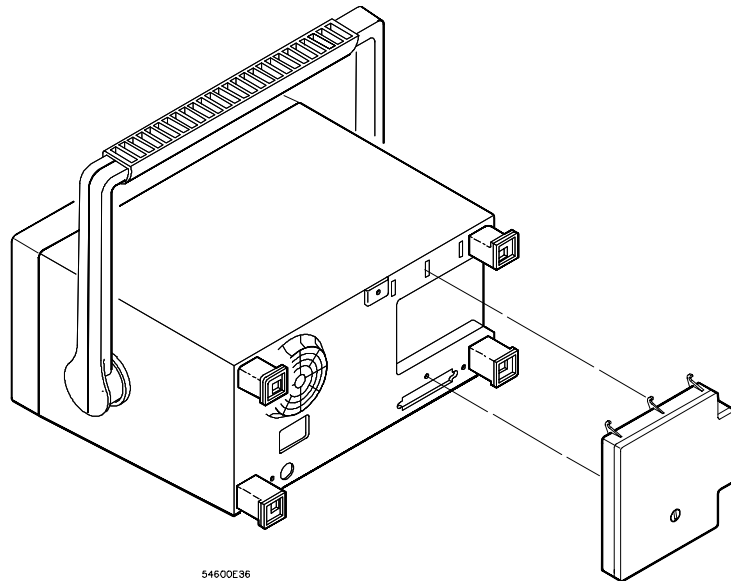

54600E36

Installing the Measurement/Storage Module

---

## To configure the interface

The Measurement/Storage Module can be connected to a printer, a plotter, or a computer through the interface. The HP 54657A has an HP-IB interface and the HP 54658A has an RS-232 interface. The HP 54659B has an RS-232 interface plus an additional parallel output connector which allows the module to be connected to both an RS-232 controller and a parallel printer at the same time.

Connect the Measurement/Storage Module to a printer, plotter, or computer through a suitable cable. The following table shows the HP part numbers of the proper cables.

---

### Interface Cables

Interface module	Cable function (Instrument to ..)	Module connector	Printer/plotter/ controller connector	HP part number	Cable Length
<b>HP 54657A (HP-IB)</b>	Printer/plotter/ controller	HP-IB	HP-IB	HP 10833A	1 m (3.3 ft)
				HP 10833B	2 m (6.6 ft)
				HP 10833C	4 m (13.2 ft)
				HP 10833D	0.5 m (1.6 ft)
<b>HP 54658A (RS-232)</b>	Printer/plotter/ controller	25-pin F	25-pin F	HP 13242G	5 m (16.7 ft)
				HP 17255M	1.5 m (4.9 ft)
	Controller	25-pin F	25-pin M	HP 92219J HP 17255D	5 m (16.7 ft) 1.5 m (4.9 ft)
	Controller	25-pin F	9-pin M	HP 24542G	3 m (9.9 ft)
<b>HP 54659B<sup>1</sup> (RS-232 and parallel output)</b>	RS-232 controller	9-pin M	25-pin M	HP 34398A	2.5 m (8.2 ft)
	RS-232 controller	9-pin M	9-pin M	HP 34398A	2.5 m (8.2 ft)
	RS-232 printer/plotter/ controller	9-pin M	25-pin F	HP 34398A + HP 34399A adapter kit	2.5 m (8.2 ft)
	Parallel printer	parallel	parallel	C2950A C2951A	2 m (6.6 ft) 3 m (9.9 ft)

<sup>1</sup> The HP 54659B is not compatible with the HP 54600A, HP 54601A, HP 54602A, and HP 54610A.

### HP 54658A Serial Connections

The signals for the RS-232 port on the HP 54658A are listed below.

Pin Number	Signal
2	Transmit Data
3	Receive Data
4	Request to Send
5	Clear to Send
6	Data Set Ready
7	Signal Ground
8	Data Carrier Detect
20	Data Terminal Ready
SHELL	Protective Ground

Figure 1-2

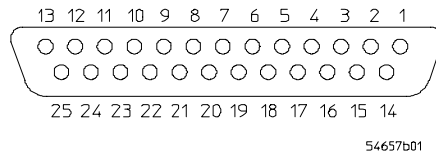

#### Pin out of HP 54658A RS-232 port looking into DB25 female connector

The following figures show the pin outs of the suggested HP RS-232 interface cables used with the HP 54658A 25-pin connector.

Installation  
To configure the interface

Figure 1-3

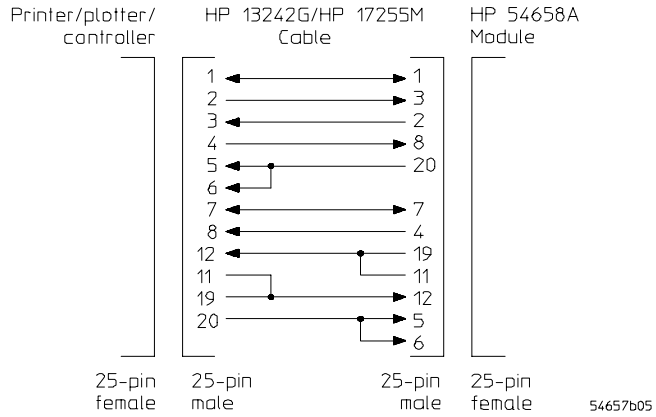

Pin out of HP 13242G/HP 17255M RS-232 cable

Figure 1-4

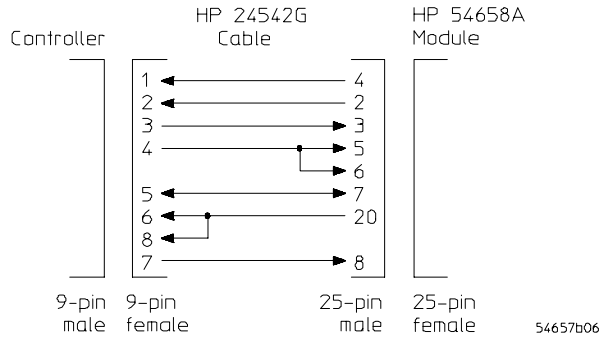

Pin out of HP 24542G RS-232 cable

Figure 1-5

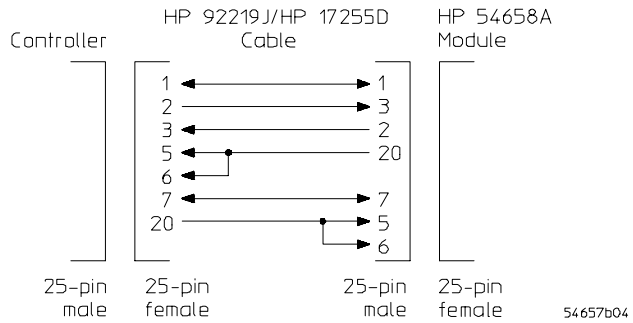

Pin out of HP 92219J/ HP 17255D RS-232 cable

### HP 54659B Serial Connections

The signals for the 9-pin RS-232 port on the HP 54659B are listed below.

Pin Number	Signal
1	Data Carrier Detect
2	Receive Data
3	Transmit Data
4	Data Terminal Ready
5	Signal Ground
6	Data Set Ready
7	Request to Send
8	Clear to Send
9	Ring
SHELL	Protective Ground

Figure 1-6

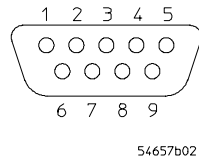

### Pin out of HP 54659B RS-232 port looking into DB9 male connector

The following figure shows the pin out of the suggested HP RS-232 interface cable used with the HP 54659B 9-pin connector.

Figure 1-7

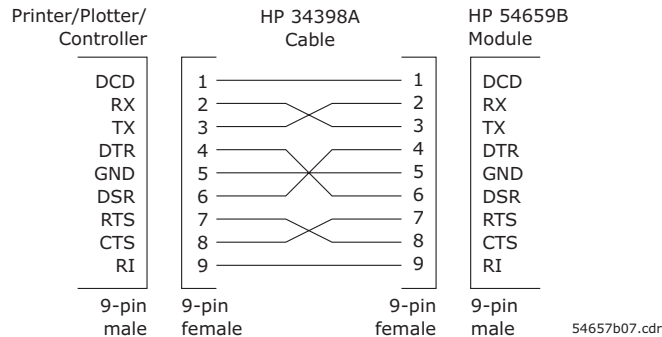

### Pin out of HP 34398A RS-232 cable

Refer to the "Programming over RS-232-C" chapter in the *HP 54600-Series Oscilloscopes Programmer's Guide* for additional information.





---

## Operating the Measurement/Storage Module

---

# Operating the Measurement/Storage Module

This chapter provides you with the information necessary to use the additional, or enhanced features that the Measurement/Storage Module provides. Basic operation for the oscilloscope is covered in the *User and Service Guide* for your oscilloscope.

This chapter provides you with practical exercises and detailed information designed to guide you through operation of the following functions:

- Math Functions
- Automatic Measurements
- Cursor Measurements
- Mask generation and waveform monitoring
- Trace Storage

---

## Math Functions

Without the Measurement/Storage module installed, addition and subtraction are the only math operations provided. In addition to the limited selections, the single function is performed on the pixel position of the data on the screen.

With the Measurement/Storage module installed, two functions define up to six operations that create mathematically altered waveforms (not pixel math.)

- Function 1 will add (+), subtract (-), or multiply (\*) the signals acquired on vertical inputs 1 and 2, then it will display the result as F1.
- Function 2 will integrate, differentiate, or perform an FFT on the signal acquired on input 1, input 2, or the result in F1; then it will display the result in F2.

The vertical range and offset of each function can be adjusted for ease of viewing and measurement considerations. Each function can be displayed, measured (with cursors), stored in trace memory, or output over the interface.

## Function 1

- 1 Press  $\boxed{\pm}$ .
- 2 Toggle the **Function 1 On Off** softkey to enable math function number 1.
- 3 Press the **Function 1 Menu** softkey  
A softkey menu with four softkey choices appears. Three of them are related to the math functions.
- 4 Toggle the **+ - \*** softkey until the desired operation is selected.  
Results (F1) are displayed on the screen.  
All operations are calculated on a point-by-point basis.
  - **plus (+)** algebraically sum input 1 and input 2 (input 1 + input 2).
  - **minus (-)** algebraically subtract input 2 from input 1 (input 1 - input 2).
  - **multiply (\*)** algebraically multiply input 1 with input 2 (input 1 \* input 2).
- 5 Press the **Units/div** softkey and rotate the knob closest to the  $\boxed{\text{Cursors}}$  key to set the vertical sensitivity of the resulting waveform.
- 6 Press the **Offset** softkey and rotate the knob closest to the  $\boxed{\text{Cursors}}$  key to set the offset (from the center graticule) of the resulting waveform.  
Function waveform (F1) is available for viewing, measurement, or storage.
- 7 Press the **Previous Menu** softkey.

### Function 1 Operating Hints

If channel 1 or 2 are clipped (not fully displayed on screen,) the resulting displayed function will also be clipped. Once the function is displayed, channel 1 and 2 may be turned off for better viewing.

When multiply is the operation selected, the value displayed for units per division and offset is ( $V^2$ ).

Offset is the value (in V or  $V^2$ ) assigned to the center graticule for function 1. Normal screen position is 0 V offset, or at the center graticule (until changed).

See "Making Cursor Measurements", and "Saving and Recalling Traces" in this chapter for more information.

---

## Function 2

Function 2 will plot differential or integral waveforms, or perform an FFT using the input signals connected to the vertical inputs (1 and 2), or using the function 1 waveform.

- 1 Press  $\boxed{\pm}$ .
- 2 Toggle the **Function 2 On Off** softkey to enable math function number 2.
- 3 Press the **Function 2 Menu** softkey.
- 4 Toggle the **Operand** softkey until the desired source is selected.  
 F1 uses the result waveform in function 1.
- 5 Press the **Operation** softkey until the desired operation is selected.  
 Results (F2) are displayed on the screen.

- **dV/dt** (differentiate) plots the derivative of the selected source using the "Central Difference" formula. Equation is as follows:

$$d_{n+i} = \frac{c_n - c_{n+1+2i}}{\Delta t(2i+1)}$$

Where

d = differential waveform

c = input 1, 2, or function 1

i = data point step size

$\Delta t$  = point-to-point time difference

- **∫dt** (integrate) plots the integral of the source using the "Trapezoidal Rule".  
 Equation is as follows:

$$I_n = \frac{\Delta t}{2} \sum (c_n + c_{n+1})$$

Where

$\Delta t$  = point-to-point time difference

c = input 1, 2, or function 1

The integrate calculation is relative to the currently selected source's input offset. The following examples illustrate any changes in offset level.

Figure 2-1

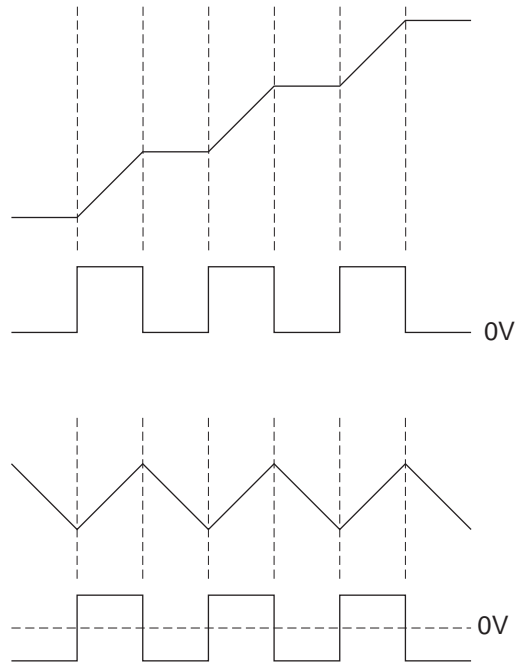

#### Integrate and Offset

- **FFT** (Fast Fourier Transform) inputs the digitized time record of the source and transforms it to the frequency domain. The FFT spectrum is plotted on the oscilloscope display as dBV (dBV or dBm for HP 54610 and HP 54615/54616) versus frequency. Selecting this function also adds the FFT Menu. See "FFT Measurement" later in this chapter for more information.
- 6** Press the **Units/div** softkey and rotate the knob closest to the **Cursors** key to set the vertical sensitivity of the resulting waveform.
- Units per division changes from volts to dB when FFT is selected.

- 7 Press the **Offset** (differentiate and integrate) or **Ref Lev** (FFT) softkey and rotate the knob closest to the **Cursors** key to set the offset (from the center graticule) or reference level (top graticule) of the resulting waveform.

Function waveform (F2) is available for viewing, measurement, or storage.

- 8 Press the **Previous Menu** softkey.

For FFT functions, an additional menu is available to set additional parameters. See "FFT Measurement" later in this chapter for more information.

### Function 2 Operating Hints

Timebase must be set to Main (and input channels 3 and 4 to Off on 4-channel oscilloscopes) when using function 2.

When differential is the operation selected, the value displayed for units per division and offset is volts per second (V/s). When integral is the operation selected, the value displayed for units per division and offset is volt seconds (Vs).

Offset is the value (in volts per second or volt seconds) assigned to the center graticule for function 2. Normal screen position is 0 offset, or at the center graticule (until changed).

See "Making Cursor Measurements", and "Saving and Recalling Traces" in this chapter for more information.

## FFT Measurement

### Operating System Requirements

Refer to "Oscilloscope Compatibility" on page 1-2 for operating system requirements for FFT operation.

FFT (Function 2) is used to compute the fast Fourier transform using vertical inputs (1 and 2), or the Function 1 waveform. This function takes the digitized time record of the specified source and transforms it to the frequency domain. When the function is selected, the FFT spectrum is plotted on the oscilloscope display as dBV (dBV or dBm for HP 54610 and HP 54615/54616) versus frequency. The readout for the horizontal axis changes from time to Hertz and the vertical readout changes from volts to dBV (dBV or dBm for HP 54610 and HP 54615/54616). For the HP 54610 and HP 54615/54616, when  $50\Omega$  input is selected, readout is in dBm; when  $1M\Omega$  input is selected, readout is in dBV. dBV is a unit of measure that is referenced to 1 Vrms. If the display of the HP 54600, HP 54601, HP 54602, HP 54603, or HP 54645 is needed to be in dBm, the operator must apply an external  $50\Omega$  load (HP 10100C or equivalent), and then perform the following conversion:

$$dBm = dBV + 13.01$$

**DC Value** The FFT computation produces a DC value that is incorrect. It does not take the offset at center screen into account and is 1.41421 times greater than its actual value. The DC value is not corrected in order to accurately represent frequency components near DC. All DC measurements should be performed in normal oscilloscope mode.



**Aliasing** When using FFT's, it is important to be aware of aliasing. This requires that the operator have some knowledge as to what the frequency domain should contain, and also consider the effective sampling rate, frequency span, and oscilloscope vertical bandwidth when making FFT measurements. Effective sample rate is briefly displayed when the  $\pm$  key is pressed.

Aliasing happens when there are insufficient samples acquired on each cycle of the input signal to recognize the signal. This occurs whenever the frequency of the input signal is greater than the Nyquist frequency (sample frequency divided by 2). When a signal is aliased, the higher frequency components show up in the FFT spectrum at a lower frequency.

The following figure illustrates aliasing. In waveform A, the sample rate is set to 200 kSa/s, and the oscilloscope displays the correct spectrum. In waveform B, the sample rate is reduced by one-half (100 kSa/s), causing the components of the input signal above the Nyquist frequency to be mirrored (aliased) on the display.

Figure 2-2

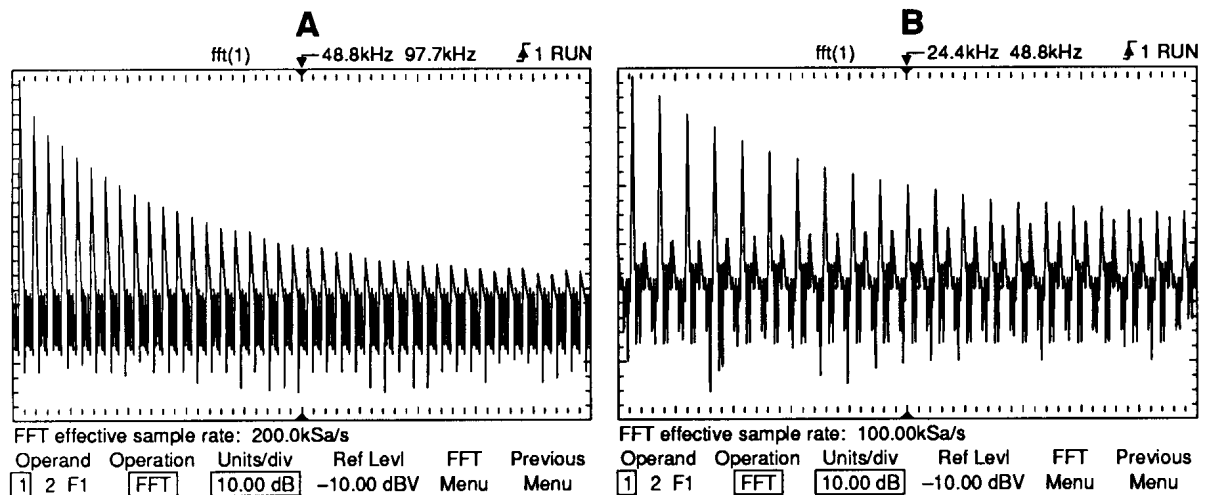

**Aliasing**

Since the frequency span goes from  $\approx 0$  to the Nyquist frequency, the best way to prevent aliasing is to make sure that the frequency span is greater than the frequencies present in the input signal.

**Spectral Leakage** The FFT operation assumes that the time record repeats. Unless there is an integral number of cycles of the sampled waveform in the record, a discontinuity is created at the end of the record. This is referred to as leakage. In order to minimize spectral leakage, windows that approach zero smoothly at the beginning and end of the signal are employed as filters to the FFT. The Measurement/Storage Module provides four windows: rectangular, exponential, hanning, and flattop. For more information on leakage, see HP Application Note 243, "The Fundamentals of Signal Analysis" (HP part number 5952-8898.)

### FFT Operation

- 1 Press  $\boxed{\pm}$ .
- 2 Toggle the **Function 2 On Off** softkey to enable math function number 2.
- 3 Press the **Function 2 Menu** softkey.
- 4 Toggle the **Operand** softkey until the desired source is selected.  
F1 uses the result waveform in function 1.
- 5 Press the **Operation** softkey until FFT is selected. Results (F2) are displayed on the screen.
- 6 Press the **Units/div** softkey and rotate the knob closest to the  $\boxed{\text{Cursors}}$  key to set the vertical sensitivity of the resulting waveform.
- 7 Press the **Ref Levl** softkey and rotate the knob closest to the  $\boxed{\text{Cursors}}$  key to set the reference level (top graticule line) of the resulting waveform.

The **Autoscale FFT** softkey will automatically set Units/div and Ref Levl to bring the FFT data on screen. Frequency Span is set to maximum. Steps 6 and 7 could be replaced to say:

- 6 Press **FFT Menu** softkey.
- 7 Press **Autoscale FFT** softkey. Rotate Time/Div knob until freq span is around the frequencies of interest.

- 8 Press the **FFT Menu** softkey.

A softkey menu with six softkey choices appears. Five of them are related to FFT.

- **Cent Freq** Allows centering of the FFT spectrum to the desired frequency. Select and rotate the knob closest to the **Cursors** key to set the center frequency to the desired value.
- **Freq Span** Sets the overall width of the FFT spectrum (left graticule to right graticule). Select and rotate the knob closest to the **Cursors** key to set the center frequency to the desired value. See FFT Measurement Hints (next page) for information on using frequency span to magnify the display.
- **Move 0Hz To Left** Pressing this key changes the center frequency so that the left most graticule represents 0 Hz.
- **Autoscale FFT** The **Autoscale FFT** softkey will automatically set Units/div and Ref Lev to bring the FFT data on screen. Frequency Span is set to maximum.
- **Window** Allows one of four windows to be selected. Select and rotate the knob closest to the **Cursors** key to set the desired window. The rectangular window is useful for transients signals and signals where there are an integral number of cycles in the time record. The hanning window is useful for frequency resolution and general purpose use. It is good for resolving two frequencies that are close together or for making frequency measurements. The flattop window is the best window for making accurate amplitude measurements of frequency peaks. The exponential window is the best window for transients analysis.
- **Previous Menu** Returns you to the previous softkey menu.

FFT spectrum (F2) is available for viewing, measurement, or storage.

- 9 The **Cursors** key contains two additional selections that can be used to measure or move the FFT spectrum. Press **Cursors** , then set the **Source** softkey to **F2**.

**Find Peaks** Pressing this key sets Vmarker1 and the start marker (f1) on the peak with the highest amplitude and sets Vmarker2 and the stop marker (f2) on the peak with the next highest amplitude. Marker values in dBV/dBm or frequency (dependent on the active cursor) are automatically displayed at the bottom of the oscilloscope screen. The difference in dBV/dBm ( $\Delta V$ ) or frequency ( $\Delta f$ ) between the two peaks is also displayed.

**Move f1 To Center** Pressing this key changes the center graticule (or center frequency) to the current f1 marker frequency. If f1 cannot be found, a message is displayed on the screen.

## Operating the Measurement/Storage Module FFT Measurement

The following FFT spectrum was obtained by connecting the front panel probe adjustment signal to input 1. Set Time/Div to 500 s/div, Volts/Div to 100 mV/div, Units/div to 10.00 dB, Ref Level to -10.00 dBV, Center Freq to 6.055 kHz, Freq Span to 12.21 kHz, and window to Hanning.

Figure 2-3

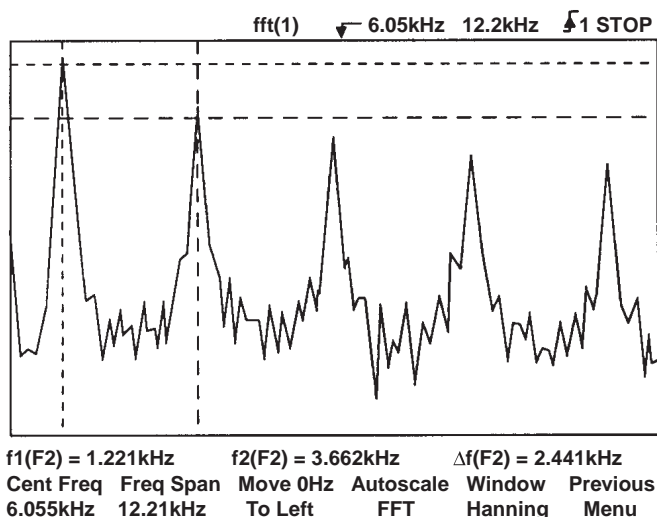

### FFT Measurements

#### FFT Measurement Hints

It is easiest to view FFT's with Vectors set to On. The Vector display mode is set in the Display menu. Note that on the HP 54615/54616, when Vectors is set from Off to On, the frequency span is halved, and when Vectors is set from On to Off, the frequency span is doubled.

The number of points acquired for the FFT record is normally 1024 (see FFT "Operating Characteristics" in Chapter 3 for specifics,) and when frequency span is at maximum, all points are displayed. Once the FFT spectrum is displayed, the frequency span and center frequency controls are used much like the controls of a spectrum analyzer to examine the frequency of interest in greater detail. Place the desired part of the waveform at the center of the screen and decrease frequency span to increase the display resolution. As frequency span is decreased, the number of points shown is reduced, and the display is magnified.

### FFT Measurement Hints – Continued

While the FFT spectrum is displayed, use the and Cursor keys to switch between measurement functions and frequency domain controls in FFT menu. See the end of the manual for display menus.

Decreasing the effective sampling rate by selecting a slower sweep speed will increase the low frequency resolution of the FFT display and also increase the chance that an alias will be displayed. The resolution of the FFT is one-half of the effective sample rate divided by the number of points in the FFT. The actual resolution of the display will not be this fine as the shape of the window will be the actual limiting factor in the FFT's ability to resolve two closely spaced frequencies. A good way to test the ability of the FFT to resolve two closely spaced frequencies is to examine the sidebands of an amplitude modulated sine wave. For example, at 2 MSa/sec effective sampling rate, a 1 MHz AM signal can be resolved to 2 kHz. Increasing the effective sampling rate to 4 MSa/sec reduces the resolution to 5 kHz.

For the best vertical accuracy on peak measurements:

- Make sure the source impedance and probe attenuation is set correctly. The impedance and probe attenuation are set from the Channel menu if the operand is a channel.
- Set the source sensitivity so that the input signal is near full screen, but not clipped.
- Use the flattop window.
- Set the FFT sensitivity to a sensitive range, such as 2 dB/division.

For best frequency accuracy on peaks:

- Use the Hanning window.
- Use cursors to place f1 cursor on the frequency of interest.
- Press **Move f1 to Center** softkey.
- Adjust frequency span for better cursor placement.
- Return to the Cursors menu to fine tune the f1 cursor.

For more information on the use of window please refer to HP Application Note 243, "The Fundamentals of Signal Analysis" Chapter III, Section 5 (HP part number 5952-8898.) Additional information can be obtained from "Spectrum and Network Measurements" by Robert A Witte, in Chapter 4 (HP part number 5960-5718.)

---

## Automatic Measurements

With the Measurement/Storage Module installed, the oscilloscope is capable of making five additional automatic voltage and time measurements.

- Delay Measurements
- Phase Measurements
- Voltage Amplitude
- Voltage Overshoot
- Voltage Preshoot

In addition to the measurements, the thresholds used for automatic time measurements are user-selectable.

Figure 2-4

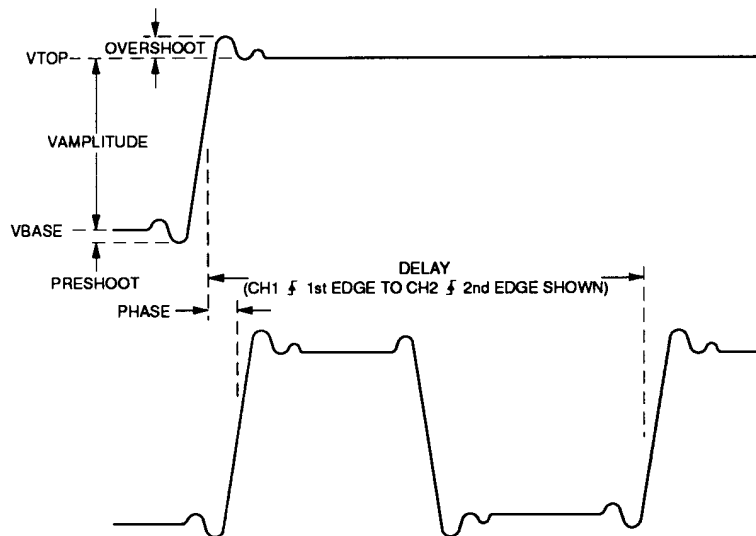

### Automatic Measurements

---

## Setting Thresholds

Without the Measurement/Storage module installed, rise time and fall time measurements are performed at the 10%/90% threshold levels. The remaining five time measurements (frequency, period, duty cycle, positive pulse width, and negative pulse width) are all performed at the 50% transition point. Refer to the *User and Service Guide* for your oscilloscope for more information.

With the Measurement/Storage module installed, the thresholds are user selectable. Rise time and fall time measurements are performed at 10%/90%, 20%/80%, or at a user defined threshold level. The remaining five time measurements are performed at the center point of the currently selected upper and lower threshold values.

- If 10%/90% is selected, the center is 50%.
- If 20%/80% is selected, the center is 50%.
- If voltage is selected, the center is dependent on the current lower and upper values.

As an example, if the lower value is set to 0 V, and the upper value is set to 50 mV, then the 50% level is 25 mV. 25 mV is the point that frequency, period, duty cycle, positive pulse width, and negative pulse width will be measured. The point of measurement is dependent on the amplitude of the input signal.

Figure 2-5

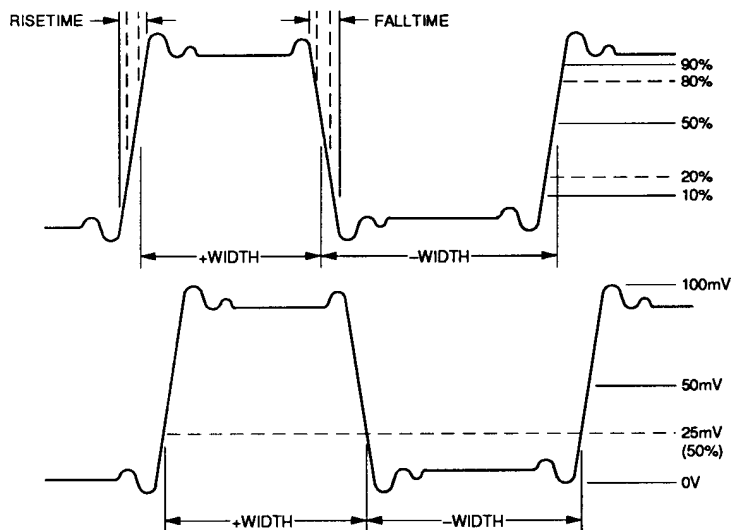

#### User Thresholds

- 1 Press **Time**.
- 2 Press the **Next Menu** softkey until the **Define Thresholds** softkey is displayed on the far left side.
- 3 Press the **Define Thresholds** softkey.
- 4 Press the desired **Thresholds** softkey.

A softkey menu with six softkey choices appears. Five of them are related to selecting thresholds.

- **10% 90%** Rise time/fall time measurements performed at the 10% (lower) and 90% (upper) levels. Frequency, period, duty cycle, positive pulse width, and negative pulse width measurements will be performed at the 50% level.
- **20% 80%** Rise time/fall time measurements performed at the 20% (lower) and 80% (upper) levels. Frequency, period, duty cycle, positive pulse width, and negative pulse width measurements will be performed at the 50% level.



- **Voltage** Rise time/fall time measurements performed at the lower and upper levels specified by you. Frequency, period, duty cycle, positive pulse width, and negative pulse width measurements will be performed at the center of both entered levels.
- **Lower** This softkey is displayed only when **Voltage** softkey is selected. Select and rotate the knob closest to the **Cursors** key to set the lower threshold to the desired value.
- **Upper** This softkey is displayed only when **Voltage** softkey is selected. Select and rotate the knob closest to the **Cursors** key to set the upper threshold to the desired value.
- **Previous Menu** Returns you to the previous softkey menu.

#### Selecting User Threshold Hints

Lower threshold level cannot be set to a value higher than the current upper threshold level.

Upper threshold level cannot be set to a value lower than the current lower threshold level.

If the upper and lower thresholds are set to levels greater to, or less than, the current displayed waveform, then the automatic rise time, fall time, frequency, period, duty cycle, positive pulse width, and negative pulse width measurements will not be performed. This is because the measurement point is not on the waveform.

Cursors can be used to set the threshold voltage levels as follows:

- Select an automatic time measurement with Show Meas set to On, and thresholds set to 10%/90%. Once initiated, the cursors will display on the waveform.
- Press Cursors key and record the current cursor voltage levels.
- Select Define Measurement Voltage, and adjust the upper and lower levels to the previously recorded values.
- Slowly rotate the knob closest to the Cursors key to fine tune the upper and lower threshold to the desired values. Cursor will track as long as the measurement is valid.

Figure 2-6

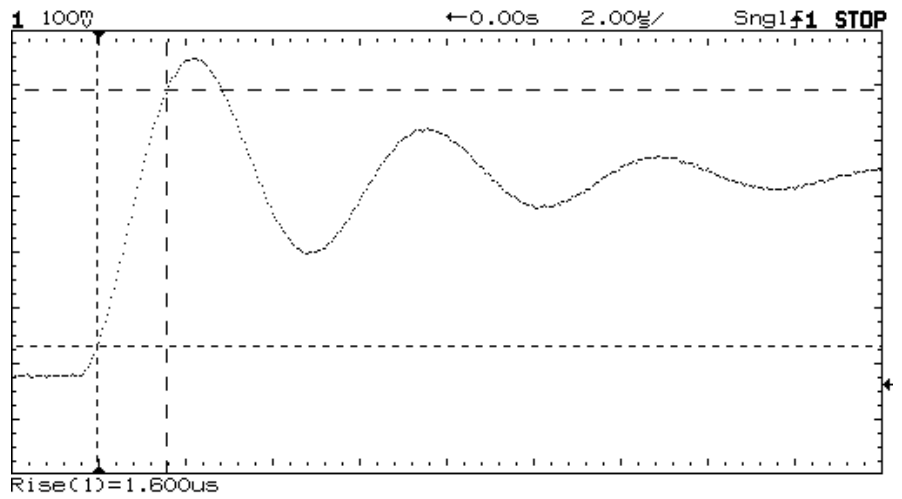

User Threshold Rise Time Measurement

---

## To make delay measurements automatically

You can measure the delay of signals connected to the oscilloscope's input 1 and input 2 connectors when the Measurement/Storage Module is connected to the oscilloscope.

Delay is measured from the user-defined slope and edge count of the signal connected to input 1, to the defined slope and edge count of the signal connected to input 2.

- 1** Adjust controls so that a minimum of 6 full cycles of the signals connected to inputs 1 and 2 are displayed.
- 2** Press Time.
- 3** Press the **Next Menu** softkey until the **Define Thresholds** softkey is displayed on the far left side.
- 4** Press the **Define Delay** softkey.

A softkey menu with five softkey choices appears. Four of them are related to defining the delay measurement.

  - **Chan 1** Selects the channel 1 slope (rising or falling) where the delay measurement will START. Threshold level is always 50%.
  - **Edge** Selects the edge count (from 1 to 5) where the delay measurement will START.
  - **Chan 2** Selects the channel 2 slope (rising or falling) where the delay measurement will STOP. Threshold level is always 50%.
  - **Edge** Selects the edge (from 1 to 5) count where the delay measurement will STOP.
  - **Previous Menu** Returns you to the previous softkey menu.
- 5** Use the displayed softkeys to specify the starting (from) and stopping (to) slope and edge count. Transition point (measurement threshold level) is fixed at 50%.
- 6** Press the **Previous Menu** softkey.

To make delay measurements automatically

7 Press the **Measure Delay** softkey. Delay is measured and displayed on the screen.

Negative delay values indicate the defined edge on channel 1 occurred after the defined edge on channel 2.

**Automatic Delay Measurement Hints**

If an edge is selected that is not displayed on the screen, delay will not be measured.

User thresholds have no effect on automatic delay measurements. Delay is always measured at the 50% transition point (measurement threshold level).

Figure 2-7

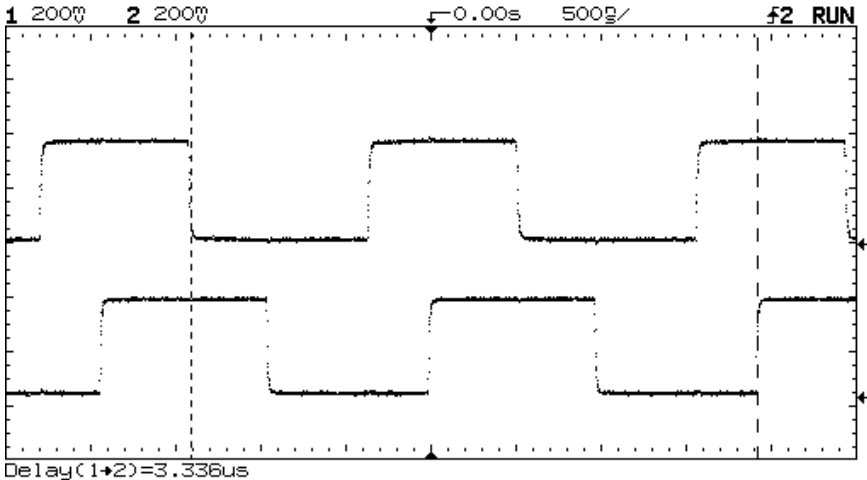

Automatic Delay Measurement

---

## To make phase measurements automatically

Phase shift between two signals can be measured using the Lissajous method. Refer to the *User and Service Guide* for your oscilloscope for more information.

With the Measurement/Storage Module installed, phase is automatically measured and displayed. Measurement is made from the rising edge of the first full cycle on the input 1 signal, to the rising edge of the first full cycle on the input 2 signal. The method used to determine phase is to measure delay and period, then calculate phase as follows:

$$\text{Phase} = \frac{\text{delay}}{\text{period of input 1}} \times 360$$

- 1 Adjust controls so that a minimum of one full cycle of the signal connected to input 1 is displayed.
- 2 Press **Time**.
- 3 Press the **Next Menu** softkey until the **Define Thresholds** softkey is displayed on the far left side.
- 4 Press the **Measure Phase** softkey. Phase is measured and displayed on the screen.

Negative phase values indicate the displayed signal on channel 2 is leading the signal on channel 1.

### Automatic Phase Measurement Hints

If one full cycle of the signal connected to input 1 is not displayed, phase will not be measured.

User thresholds has no effect on automatic phase measurements. Phase is always measured at the 50% transition point (threshold level).

When using the delayed timebase, the instrument will attempt to perform the measurement using the delayed window. If the selected channel 1 edge, channel 2 edge, and channel 1 period cannot be found in the delayed window, the main window is used. See "Time Measurements" in the *User and Service Guide* for your oscilloscope for more information.

Figure 2-8

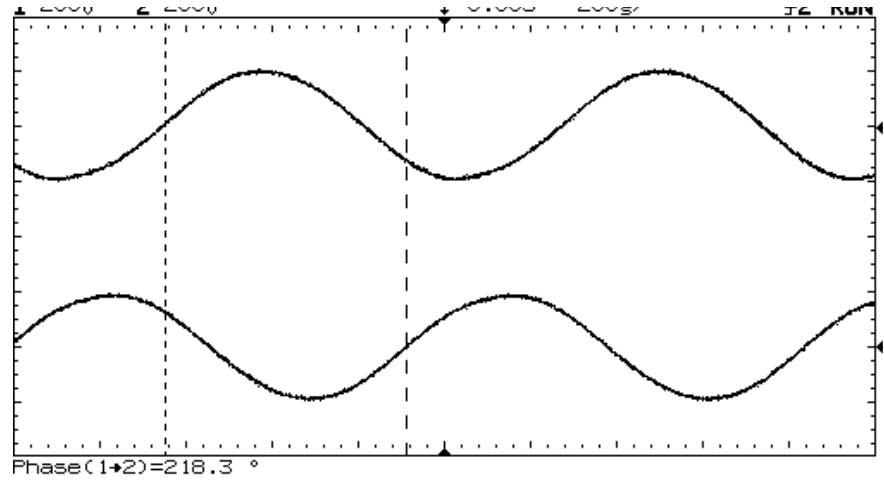

Automatic Phase Measurement

---

## To make additional voltage measurements automatically

With the Measurement/Storage Module is installed, the following additional automatic voltage measurements can be performed.

- **Vamplitude** Amplitude Voltage measurement is made using the entire waveform. When performing a measurement on a particular cycle, set the controls to display only that cycle is displayed. The method used to determine voltage amplitude is to measure  $V_{top}$  and  $V_{base}$ , then calculate voltage amplitude as follows:

$$\text{voltage amplitude} = V_{top} - V_{base}$$

- **Vovershoot** A minimum of one edge must be displayed in order to perform an Overshoot measurement. If more than one waveform, edge, or pulse is present, the measurement is made on the first edge acquired. The method used to determine overshoot is to make three different voltage measurements, then calculate overshoot as follows:

$$\text{percent overshoot} = \frac{V_{max} - V_{top}}{V_{top} - V_{base}} \times 100$$

- **Vpreshoot** A minimum of one edge must be displayed in order to perform a Preshoot measurement. If more than one waveform, edge, or pulse is present, the measurement is made on the first edge acquired. The method used to determine preshoot is to make three different voltage measurements, then calculate preshoot as follows:

$$\text{percent preshoot} = \frac{V_{min} - V_{base}}{V_{base} - V_{top}} \times 100$$

Operating the Measurement/Storage Module  
To make additional voltage measurements automatically

- 1 Adjust controls until the desired signal is displayed.
- 2 Press **voltage** .
- 3 Press the **Source** softkey until the desired source is selected.
- 4 Press the **Next Menu** softkey until the **Vamp** softkey is displayed on the far left side.
- 5 Press the desired **Voltage Measurement** softkey.
  - **Vamp** Select to perform a voltage amplitude measurement.
  - **Vover** Select to perform an overshoot measurement.
  - **Vpre** Select to perform a preshoot measurement.

Figure 2-9

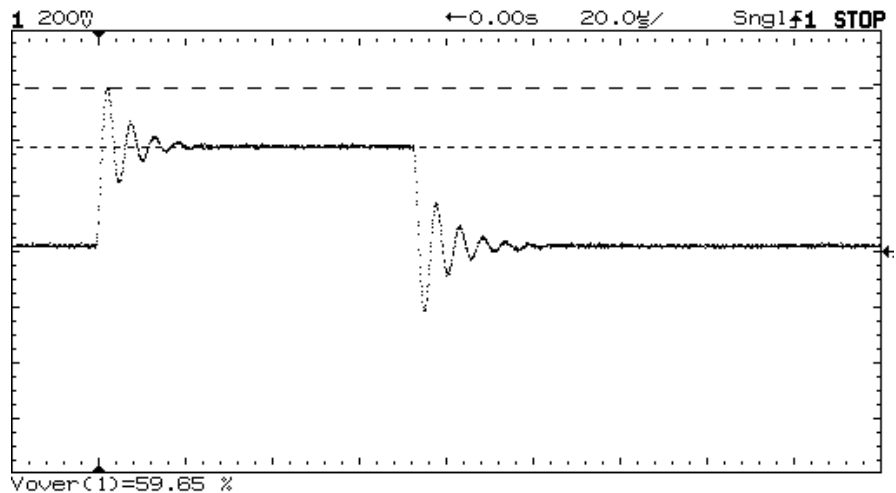

Automatic Overshoot Measurement



---

## To make additional cursor measurements

Without the Measurement/Storage Module installed, cursor measurements can be performed on channels 1 through 4, and are displayed in volts (V1/V2) and time (t1/t2). Refer to the *User and Service Guide* for your oscilloscope for more information.

With the Measurement/Storage Module installed, additional cursor measurement features include:

- Measurements can now be performed on functions 1 and 2.
- You can define voltage marker units as either volts or relative percent.
- You can define the time units as either seconds or relative degrees.

**1** Adjust controls until the desired signal is displayed.

**2** Press **Cursors** .

**3** Toggle the **Source** softkey until the desired source is selected (channels 1 through 4, functions 1 and 2).

**4** Press the **Active Cursor V1 V2** softkey.

**5** Toggle the **Readout** softkey to select voltage markers in percent.

If Readout Volts is selected, cursor measurements are displayed in volts (V1, V2, and  $\Delta V$ ), and operation is identical as when the module is not installed. Refer to the *User and Service Guide* for your oscilloscope for more information.

**6** Toggle the **Active Cursor V1 V2** softkey until the desired marker(s) (V1, V2, or both) are selected, and rotate the knob closest to the **Cursors** key to set the marker(s) to the desired position.

When both V1/V2 markers are selected, rotating the knob closest to the **Cursors** key moves both markers.

**7** Press the **Set 100%** softkey to set the V1 marker to 0% and the V2 marker to 100%. All readings are now relative to the established V1/V2 marker positions.

- V1 reads the percentage the V1 marker has moved from the established 0% position. Negative readings indicate marker has moved away from the V2 marker.

To make additional cursor measurements

- V2 reads the percentage the V2 marker has moved from the established 100% position. Negative readings indicate marker has moved through the established V1 marker position.
- $\Delta V$  reads the percentage difference between the V1 and V2 marker repetitive to the established positions. Negative readings indicate markers have crossed.

Figure 2-10

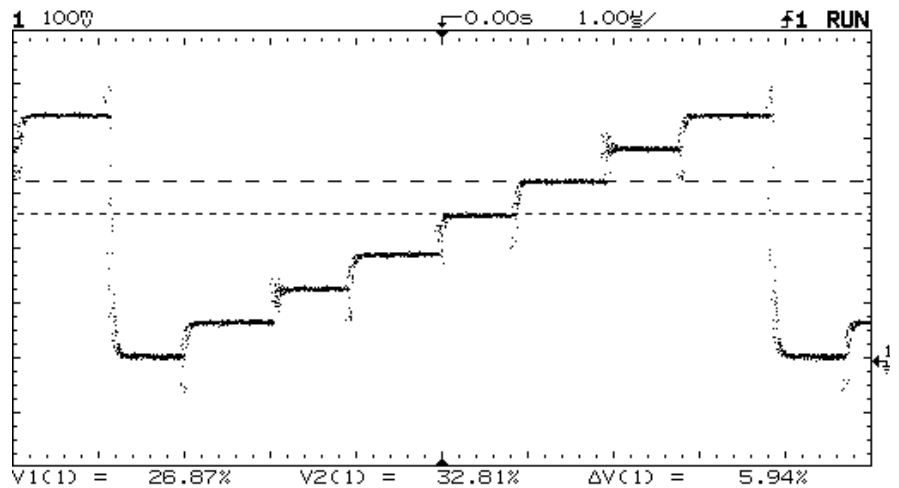

Voltage Cursor Measurements in Percent

8 Press the **Active Cursor t1 t2** softkey.

9 Toggle the **Readout** softkey to select time markers in degrees.

If Readout Time is selected, cursor measurements are displayed in seconds (t1, t2, and  $\Delta t$ ), and Hz ( $1/\Delta t$ ). Operation is identical as when the module is not installed. Refer to the *User and Service Guide* for your oscilloscope for more information.

10 Toggle the **Active Cursor t1 t2** softkey until the desired marker(s) (t1, t2, or both) are selected, and rotate the knob closest to the

**Cursors** key to set the marker(s) to the desired position.

When both t1/t2 markers are selected, rotating the knob closest to the

**Cursors** key moves both markers.

- 11 Press the **Set 100%** softkey to set the t1 marker to  $0^\circ$  and the t2 marker to  $360^\circ$ . All readings (except second  $\Delta t$  display in seconds) are now relative to the established t1/t2 marker positions.
- t1 reads the phase the t1 marker has moved from established  $0^\circ$  position. Negative readings indicate marker has moved away from the t2 marker.
  - t2 reads the phase the t2 marker has moved from established  $360^\circ$  position. Negative readings indicate marker has moved through the established t1 marker position.
  - $\Delta t$  in degrees reads the phase difference between the t1 and t2 marker repetitive to the established positions. Negative readings indicate markers have crossed.
  - $\Delta t$  in seconds reads the time difference between the t1 and t2 marker positions. Negative readings indicate markers have crossed.

#### Additional FFT Function Keys

When the FFT function is selected (refer to Math Functions), two additional keys are available as follows:

**Find Peaks** Pressing this key sets Vmarker1 and the start marker (f1) on the FFT trace peak with the highest amplitude and sets Vmarker2 and the stop marker (f2) on the peak with the next highest amplitude. Marker values in dBV or frequency (dependent on the active cursor) are automatically displayed at the bottom of the oscilloscope screen. The difference in dBV ( $\Delta V$ ) or frequency ( $\Delta f$ ) between the two peaks is also displayed.

**Move f1 To Center** Pressing this key changes the center graticule (or center frequency) to the current f1 marker frequency. If f1 cannot be found, a message is displayed on the screen.

To make additional cursor measurements

**Cursor Measurement Hints**

If cursors are positioned too closely together, an error will be displayed when the **SET** softkey is selected.

Displayed marker readings in percent (%) and degrees (°) are always relative measurements, with the current reading dependent on the previously established 100% or 360 reference setting.

Figure 2-11

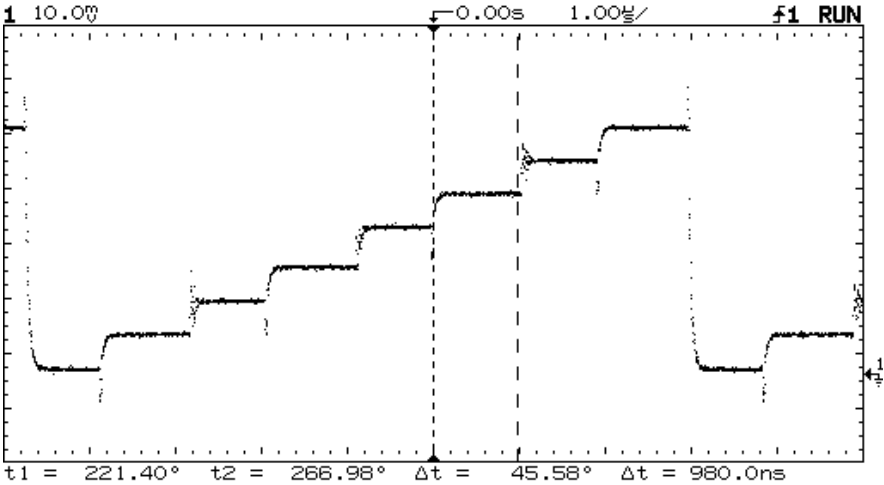

Time Cursor Measurements in Degrees

---

## Unattended Waveform Monitoring

The Measurement/Storage Module simplifies circuit debugging by comparing an active channel (not functions) trace on the display to one of two test templates.

When a failure is detected, the oscilloscope can be instructed to take one of several actions.

- The test can be set to stop after the first failure, or to continue regardless of the number of failures found.
- The failed trace(s) can be stamped with the date and time of the failure, and stored in trace memory or output to a hardcopy device. When trace memory is selected, the user has the option of saving all failures, or saving only the last failure that occurred.
- The test can continue with statistics on the number of failures (reported as a percentage of the number of tests performed) being displayed.

The mask templates can be defined one of two ways. Once a mask is created, it is stored in nonvolatile RAM.



- **Automask** Quickly generates a mask template from currently displayed data. You are allowed to select the mask tolerance prior to creating the template.
- **Editor** Used to adjust the tolerances of a previously created template in areas of specific interest, or to create a complete new mask. Mask editor allows pixel-by-pixel editing, and smoothing of the mask by using a running average of three pixels.

Failures can be specified one of two ways.

- **Inside** Test fails if signal falls inside the region defined by the maximum and minimum limit lines of the mask template.
- **Outside** Test fails if signal falls outside the region defined by the maximum and minimum limit lines of the mask template.

## To create a mask template using Automask

A mask template contains two limit lines: minimum and maximum. Automask allows you to easily generate a mask with tolerances from a displayed waveform on the screen.

- 1 Connect a known good signal to the oscilloscope.
- 2 Set up the oscilloscope with the settings that are required to test the signal.
- 3 Press .
- 4 Press the **Mask Test** softkey.
- 5 Toggle the **Use Mask** softkey to select the desired mask number (1 or 2).
- 6 Press the **Define Mask Automask** softkey.
- 7 Press the **Tolerance** softkey, then turn the knob closest to the  key to set the tolerance.

Pressing the softkey increases the tolerance value by 0.2%.

- 8 Press the **Create Mask** softkey to create the mask with the specified tolerance.

### Tolerance Operating Hint

The tolerance used in Automask is expressed as a percentage of the full-scale time and voltage of the lowest number of all active channels. It does not represent the tolerance of the actual size of the input signal. To specify the tolerance as a percentage of the actual size of the input signal requires some additional calculations.

For example, a signal of 1 volt peak-to-peak is tested at a vertical sensitivity of 500 mV/div. The full-scale voltage equals the volts/div times the number of full-scale divisions (500 mV \* 8 = 4 V). To specify a 4% tolerance on a 1 V peak-to-peak signal requires a 40 mV tolerance, but to specify a 40 mV tolerance on a full-scale voltage of 4 volts requires a 1% tolerance. Therefore, a 1% tolerance should be specified to generate the mask template.

---

## To create a mask template using Autostore

An envelope of the passing region can be generated using the Autostore function. Then the Automask function can read the Autostore screen information and take the maximum and minimum limits of it as the limit lines of the mask template. This process allows you to create a mask template from a known good signal, allowing certain tolerance margins.

- 1** Connect a known good signal to the oscilloscope.
  - 2** Set up the oscilloscope with the settings that are required to test the signal.
  - 3** Press **Display**, then toggle the **Grid** softkey to the **None** position.
  - 4** Press **Autostore**.
- Make sure that STORE is displayed in the status line. If STORE is not displayed, press Autostore again.
- 5** Set the voltage tolerance by moving the waveform up and down with the vertical position knob, creating a vertical envelope.
  - 6** Set the time tolerance by moving the waveform back and forth with the horizontal delay knob, creating a horizontal envelope.
- You may need to repeat steps 5 and 6 to fine tune the envelope. Cursors can be used to accurately measure the margins.
- An alternative method is to vary the input signal amplitude (level) and frequency (time) by the desired amount.
- 7** Press **±**.
  - 8** Press the **Mask Test** softkey.
  - 9** Press the **Use Mask** softkey to select the desired mask number (1 or 2).
  - 10** Press the **Define Mask Automask** softkey.

- 11 Press the **Tolerance** softkey, then turn the knob closest to the **Cursors** key to set the tolerance to  $\pm 0.0\%$ .

If additional tolerance is desired, set the tolerance to the appropriate level. This will be the amount "added on" to the previously created envelope.

- 12 Press the **Create Mask** softkey to create the mask from the autostore information.

#### **Automask Using Autostore Operating Hint**

The Automask function takes all the information displayed in half bright to create the mask. However, the display grid and the autostore information shares the same half-bright display. If the grid is turned on, and Autostore information is on the screen when the Create Mask softkey is pressed, a warning message is displayed: "Grid must be None to generate mask with Autostore." The Display Grid must be turned to None prior to creating the autostore data in order to use Automask function. Turning the grid to None after the autostore data is created erases both the grid and the autostore data. Use of cursors does not affect the Automask function and is highly recommended to ensure the proper testing margin in the autostore information.

If there is noise rising on the limit lines, you can use the smooth function in the mask editor to smooth out the noise.



---

## To create or edit a mask using line segments

The Measurement/Storage Module has a built-in Mask Editor for creating or editing masks. It provides two editing tools: pixel editing and line drawing editing. The line drawing editing tool can also be used to create a mask using line segments.

To create the mask, you may want to first draw the mask on a piece of paper and mark the coordinates of the end points of each straight line.

- 1 Press   $\pm$ .
- 2 Press the **Mask Test** softkey.
- 3 Press the **Use Mask** softkey to select the desired mask number (1 or 2).
- 4 Press the **Define Mask Editor** softkey.

A softkey menu with five softkey choices appears. Four of them are related to the mask editing functions.

If a mask has been previously created, it will be displayed.

- **Edit Line** Selects the limit line to be edited. Minimum is selected to edit the bottom limit line, and maximum is selected to edit the top limit line.
- **Line Drawing - Mark and Connect** Mark and Connect are used for drawing straight lines in the mask. Their operation is explained later in this paragraph.
- **Smooth Mask** A running average of three pixels is used to smooth the mask. It is especially useful for smoothing a mask created by Automask, which may contain noise on the mask.  
Each time Smooth Mask is selected, the entire mask is updated. Selecting smoothing numerous times can alter the desired mask pattern.
- **Previous Menu** Returns you to the previous softkey menu.

- 5 Toggle the **Edit Line** softkey to select the limit line you want to edit.
- 6 Turn the Delay knob to move the X-coordinate of the cursor to the time corresponding to the first point.  
If a mask has been previously created, both the X and Y coordinate of the cursor will track the selected limit line.
- 7 Turn the knob closest to the **Cursors** key to move the Y-coordinate of the cursor to the voltage corresponding to the first point.
- 8 Press the **Mark** softkey to mark this point as the first point of a line draw.
- 9 Turn the delay knob to move the X-coordinate of the cursor to the time corresponding to the second point.
- 10 Turn the knob closest to the **Cursors** key to move the Y-coordinate of the cursor to the voltage corresponding to the second point of the line.
- 11 Press the **Connect** softkey to draw the line between both points.
- 12 Repeat procedures 5 through 11 until the desired mask is created.

#### Mask Editor Operating Hint

When you want to move the cursor to a particular location, it is essential to first move the X-coordinate of the cursor then the Y-coordinate. Otherwise, the movement of the Y-coordinate changes the position of a pixel at an undesired location.

After you press the Connect softkey, the two points are connected by a straight line. Points between the two end points are interpolated. However, if the voltage of a particular point during interpolation violates the rule of the voltage at the maximum limit  $\geq$  the voltage at the minimum limit, the voltage is set to the same value as the other limit.

After you have marked the first point, pressing the Mark softkey again cancels the previously marked point and starts the procedure over.

After you have connected the two points, pressing the Connect softkey again will undo the connect operation.

---

## To edit an individual pixel of a mask

Previously created masks can be edited pixel-by-pixel using the line drawing editing tool. The Delay knob selects the column to be edited, and the Cursors knob moves the mask vertically.

- 1 Press  $\boxed{\pm}$ .
- 2 Press the **Mask Test** softkey.
- 3 Press the **Use Mask** softkey to select the desired mask number (1 or 2).
- 4 Press the **Define Mask Editor** softkey.
- 5 Toggle the **Edit Line** softkey to select the limit line that you want to edit.
- 6 Turn the Delay knob to move the cursor to the pixel (column) that you want to modify.
- 7 Turn the knob closest to the  $\boxed{\text{Cursors}}$  key to edit the vertical position of the pixel.

It is possible to repeat steps 6 and 7 (simultaneously) using two hands to create a nice smooth mask.

### Pixel Editing Operating Hint

The time and voltage shown at the bottom of the screen corresponds to the current time base and vertical setting of lowest number of all active channels. If the mask is voltage and time dependent, make sure that the current time base and vertical setting are the same as the one that you are going to use during the actual testing.

Once the Cursor knob is moved, the selected pixel is edited. To remove undesired edits, use the mark and connect softkeys (previously discussed).

## To edit the mask to test only a portion of a waveform

In certain circumstances, not all the points on the waveform need to be tested. Only the area of interest needs to be tested. For example, to test the amount of overshoot of a pulse, you only need to test the portion of the waveform after the rising edge. You can select the test region by editing the shape of the mask template.

- 1 Press  $\boxed{\pm}$ .
- 2 Press the **Mask Test** softkey.
- 3 Press the **Use Mask** softkey to select the desired mask number (1 or 2).
- 4 Press the **Define Mask Editor** softkey.
- 5 Toggle the **Edit Line** softkey to select the limit line that you want to edit.
- 6 Turn the Delay knob to move the cursor to the starting location that you do not want to test.
- 7 Turn the knob closest to the  $\boxed{\text{Cursors}}$  key to move the voltage cursor until it reads "Don't Care".
- 8 Press the **Mark** softkey.
- 9 Turn the Delay knob to move the cursor to the ending location of the region that you do not want to test.
- 10 Turn the knob closest to the  $\boxed{\text{Cursors}}$  key to move the voltage cursor until it reads "Don't Care".
- 11 Press the **Connect** softkey.

This region of this particular limit line is not tested during the mask testing.

### Mask Editing Operating Hint

Each limit line can have its own selectable test region.

The figure below shows a mask that tests the overshoot of the waveform. Note that only the part you are interested in is tested. The test region can be set individually for the maximum and minimum limit.

Figure 2-12

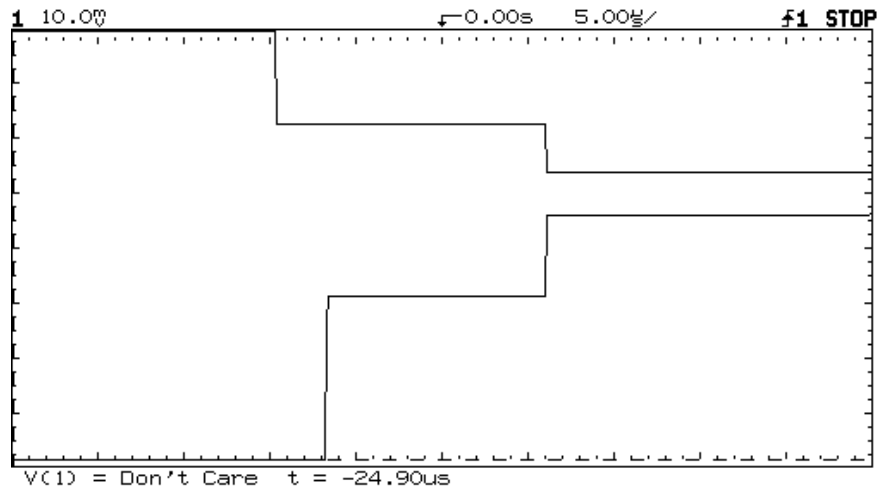

Example mask template with selectable test region

## To start waveform monitoring

Before using a testing mask to monitor a waveform, the mask must be created. Once created, the mask is automatically stored in one of the two nonvolatile mask memories. Procedures for creating a mask template are provided in this chapter.

- 1 Press  $\boxed{\pm}$ .
- 2 Press the **Mask Test** softkey.
- 3 Press the **Use Mask** softkey to select the previously created mask number (1 or 2).
- 4 Press the **Test Options** softkey.

A softkey menu with six softkey choices appears. Five of them are related to the mask testing functions.

- **Fail When – In or Out** Selects if a test failure occurs when the signal moves out of, or in to the mask template.
- **On Fail - Stop or Run** Used to select what state the oscilloscope will be in after a test violation has occurred.

When stop is selected, the current acquisitions stop when the first violation of the mask occurs. The test can be restarted by pressing the RUN key.

When run is selected, the oscilloscope continues to acquire data and display the most recent trace.

- **Auto Save – Off or On** Used to select if a test violation waveform is recorded. When On is selected, an additional softkey appears. See "Automatically Saving Test Violations" later in this chapter for more information.
- **Save To** This softkey is displayed only when **Auto Save On** is selected. Toggle softkey to direct test failure data to the Trace memory, or to the Printer. When Trace is selected, an additional softkey appears.

- **Increment** This softkey is displayed only when **Save To Trace** is selected.

When On, all test violations are saved by incrementing the trace number. The starting trace number is the one that is currently selected. When the 64K compressed memory is full, the oldest trace memory is overwritten, and the trace count continues incrementing. When the trace count reaches 100, the number resets to 1 (wraps around).

When Off, only the last test violation is saved, as test failure data is written over previously stored data.

- **Previous Menu** Returns you to the previous softkey menu.

5 Toggle the softkeys to select the desired testing options.

6 Press the **Previous Menu** softkey.

7 Press the **Mask Test** softkey until **On** is selected.

Selecting on immediately starts the test using the test options specified. Test indications are displayed on the display line as follows.

- **Pass** Indicates the displayed waveform passed the test.
- **Fail** Indicates the displayed waveform failed the test. Further testing, and disposition of the failed data is dependent on the testing options selected.
- **Acquisitions** Indicates the total acquisitions made during the test.
- **Failures** Indicates the total number (and percentage) of test failures that occurred during the test.

#### Waveform Monitoring Operating Hint

Mask template testing can only be used in the Main Horizontal Mode, and when Functions 1 and 2 are set to off.

The trace review softkey can be used to review all saved failures. See "To Save or Recall Traces" in this chapter for more information.

## To automatically save test violations

The signals that fail the waveform monitoring test can be saved, then viewed/measured at a later time. Provisions are provided to save the violations in trace memory, or print a hardcopy of the data. When trace is selected, the option of saving only the last violation, or saving all violations are provided.

- 1 Setup for waveform monitoring as described previously.
- 2 Press .
- 3 Press the **Mask Test** softkey.
- 4 Press the **Test Options** softkey.
- 5 Press the **Auto Save** softkey to **ON**. This causes the **Save To** softkey to appear. Determine how the test violations are being saved, and proceed as follows:
  - To print test violation data on an externally connected printer, toggle the **Save To** softkey until **Print** is selected.
  - To save test violation data in trace memory, toggle the **Save To** softkey until **Trace** is selected. This causes the **Increment** softkey to appear.
  - To save only the last test violation waveform in trace memory, toggle the **Increment** softkey until **Off** is selected.
  - To save all test violation waveforms in trace memory, toggle the **Increment** softkey until **On** is selected.
- 6 Press the **Previous Menu** softkey.
- 7 Press the **Mask Test** softkey until **On** is selected.



### **Saving Test Violation Data Operating Hint**

When Increment On is selected, traces  $\geq 3$  to 100 are stored in the compressed state. During the compression and storage of data, new signals are not acquired or tested. The time it takes to compress and store data is less than 10 seconds.

When Increment On is selected, and multiple violations are desired, the On Fail softkey must be set to Run (in the Test Options menu). The starting trace number is the one that is currently selected. When the 64K compressed memory is full, the oldest trace memory is overwritten, and the trace count continues incrementing. When the trace count reaches 100, the number resets to 1 (wraps around).

### Creating a delay testing mask

A mask can be used to test the channel to channel delay of two input signals. The shape of the mask varies depending on the channel 2 edge selected (stop edge). Different masks are needed for different edge selections.

To test the channel to channel delay of the signal connected to channel 2, the stop edge of the signal is tested instead of actually measuring the delay. The test can be conducted by triggering on the start edge (channel 1), and testing for the location of the stop edge (channel 2). An example mask is shown in the following figure.

Figure 2-13

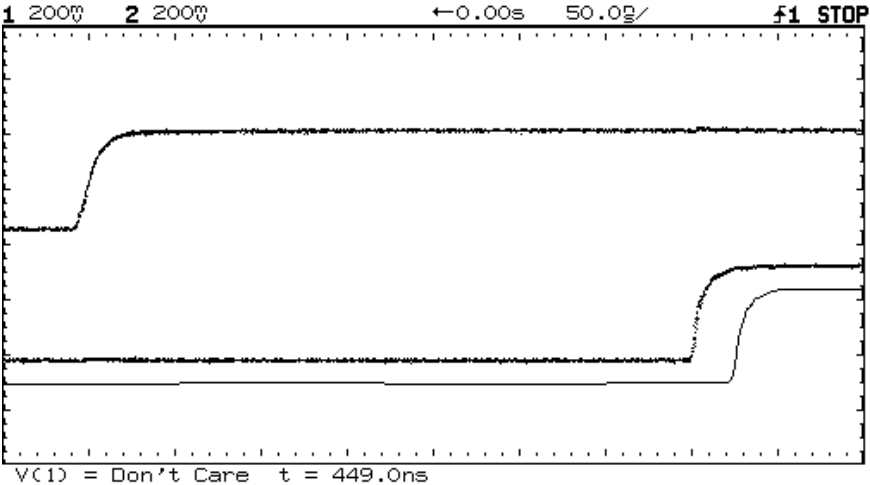

Example of a mask template used in channel to channel delay

The following procedure can be used to setup a mask template for testing channel to channel delay.

In the oscilloscope setup, the controls should be selected to display the start edge (channel 1) as the first edge on the display, and the stop edge (channel 2) as the last edge on the display. The trigger source should be set to trigger from channel 1. The mask template can be created by using an external signal source to generate the signals identical to the ones that are going to be tested.

- 1** Connect the desired signals to the oscilloscope.
- 2** Set the signal source(s) to generate a waveform identical to the ones that you are going to test.
- 3** Press  on the oscilloscope, then press the **Mask Test** softkey.
- 4** Create a mask (at the desired tolerance) using Automask. Press **Previous Menu** softkey when finished.  
Refer to "Create a Mask Template Using Automask" for more information on using automask.
- 5** Press the **Define Mask Editor** softkey.
- 6** Toggle the **Edit Line** softkey to select the **Min** limit line. Use the **Mark** and **Connect** softkeys to edit the minimum line so only the last edge is present (refer to previous figure).  
Refer to "Create or Edit a Mask Using Line Segments" for additional information.
- 7** Toggle the **Edit Line** softkey to select the **Max** limit line. Use the **Mark** and **Connect** softkeys to edit the minimum line so only the first edge is present (refer to previous figure). Press **Previous Menu** softkey when finished.

## Creating a frequency testing mask

A mask can be used to test the frequency of the input signal. The shape of the mask varies depending on the shape of the signal to be tested. A mask designed for testing a sine wave cannot be used to test a square wave. Different masks are needed for different shapes of signals. Using the calibrated vertical vernier, position, and time base of the HP 54600-Series oscilloscope, a mask can be re-used to test signals of similar shapes but different frequencies and amplitudes.

To test the frequency of the signal, the period of the signal is tested instead of actually measuring the frequency. The test can be conducted by triggering on an edge of the signal and testing for the location of the second edge. An example mask is shown in the following figure.

Figure 2-14

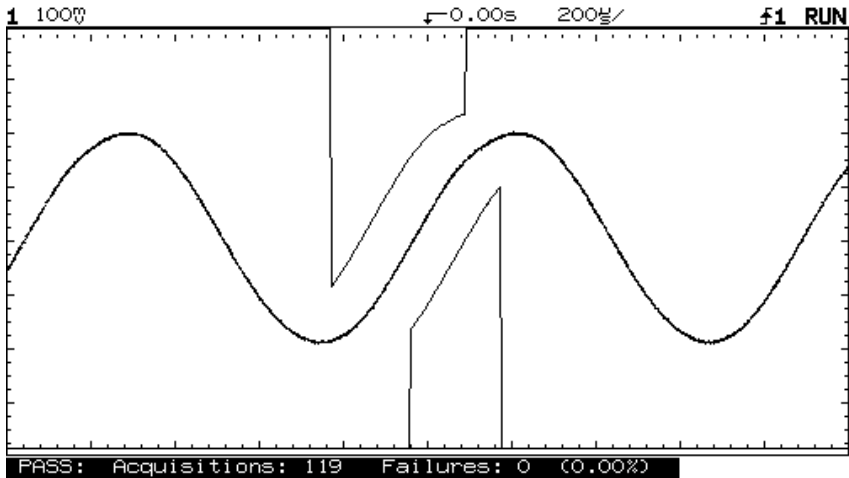

Example mask for testing the frequency of a sine wave

The following procedure can be used to setup a mask template for testing the frequency of a sine wave or a square wave. Similar methods can be used to generate masks for testing the frequency of signals of other shapes.

In the oscilloscope setup, the vertical sensitivity and position should be adjusted so that the amplitude is almost full scale. The trigger level should be adjusted to the middle of the input signal. The mask template can be created by using a function generator to generate a signal of variable frequency but of similar shape and amplitude to the one that is going to be tested.

- 1** Connect the output of a function generator to the oscilloscope.
- 2** Set the function generator to generate a waveform with a similar shape to the one that you are going to test.
- 3** Adjust the amplitude of the output until it is similar to the signal that you are going to test.
- 4** Press **Time** on the oscilloscope, then press the **Freq** softkey to turn on the automatic measurement for frequency.
- 5** Adjust the frequency of the output of the function generator to the lower test limit.

The frequency can be verified by the automatic measurement.

- 6** Press **Autostore**.
- 7** Adjust the frequency of the output of the function generator to the upper test limit.  
An envelope of the test limit is generated.
- 8** Create a mask in the Define Automask menu with a tolerance of 0.0%.  
For more information, refer to "To Create a Mask Template Using Autostore" in this chapter.
- 9** Specify your test region in the Mask Editor menu.

## Creating an overshoot testing mask

There are two parameters associated with the overshoot of a signal: the percentage of overshoot and the settling time of the overshoot. A mask template can be created to test the upper limit of these two parameters at the same time. The following figure shows an example of a mask template for testing overshoot.

Figure 2-15

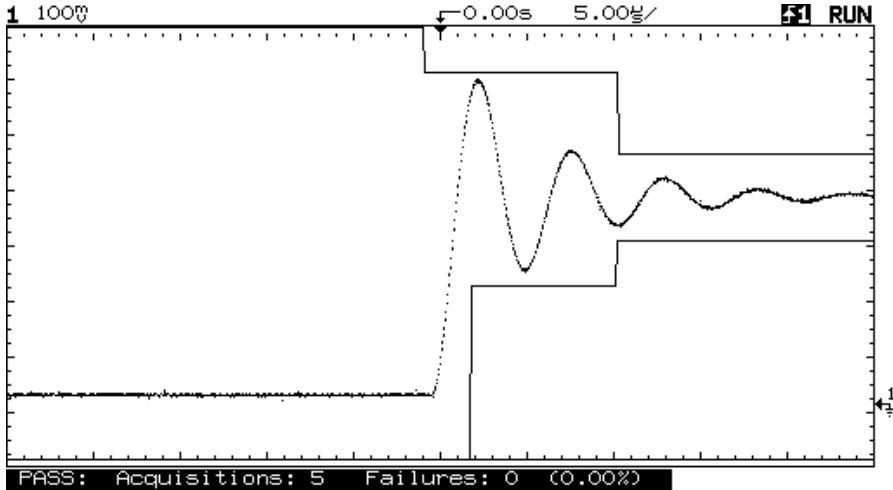

Example of a mask template for testing overshoot

The critical factors for creating the mask template are:

- The vertical window of the middle region of the mask template determines the upper limit of the overshoot.
- The horizontal window of the middle region determines the upper limit of the settling time.
- The vertical window of the rightmost region determines the settling window. Normally, the settling window is  $\pm 5\%$  or  $\pm 10\%$  of the  $V_{top}$  voltage.

## Creating a rise time testing mask

Mask template testing can be used to test the rise time of a signal, including specifying an upper limit for rise time. For example, you can specify that the rise time must be 15 ns or faster to pass the test.

Use the voltage and time readouts of the mask editor to ensure the correct settings. In the following figure, T1 and T2 are the critical points for determining the maximum rise time limit (rise time limit = T2 - T1).

Figure 2-16

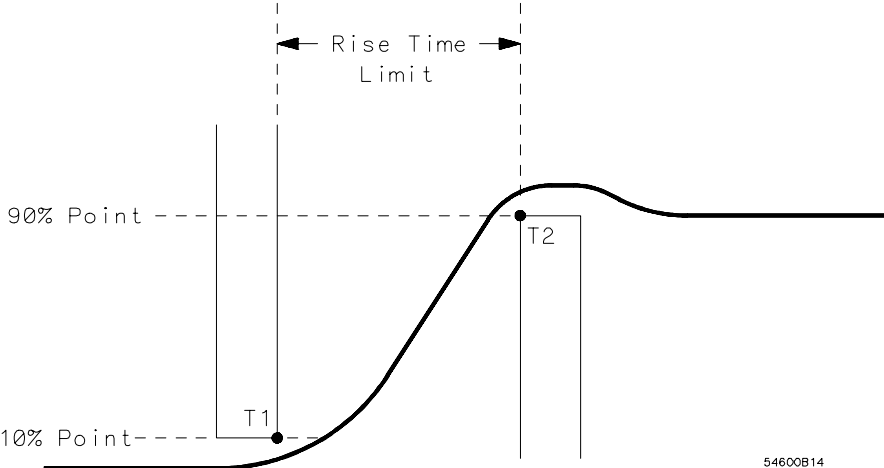

Example of a definition of a rise time testing mask



- 1 Determine the top and base of the signal.  
Use the automatic measurement **Vtop** and **Vbase** of the oscilloscope to determine these values.
- 2 Calculate the 10% and 90% points.
- 3 Determine the upper limit for the rise time.
- 4 Draw the mask template using the mask editor.  
The mask should look similar to the one in the following figure.

Figure 2-17

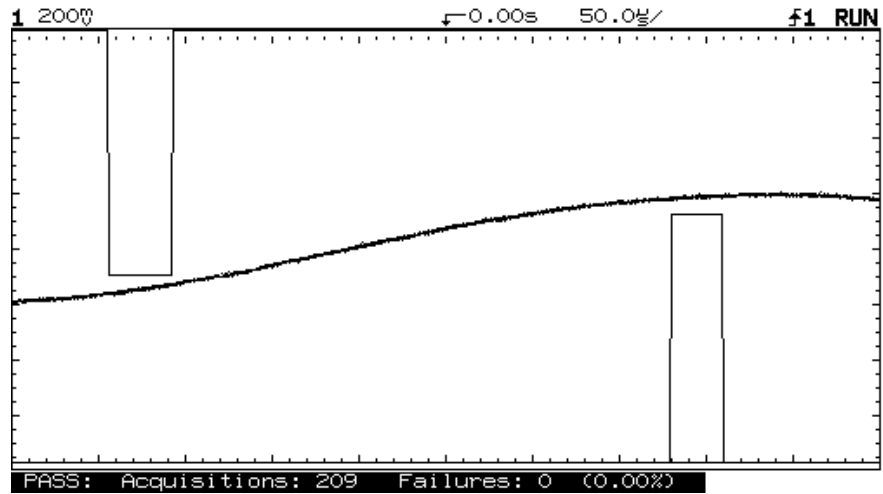

Example of a mask template for testing rise time

## Testing the eye opening of an eye-pattern signal

There are generally two tests that you want to perform on an eye-pattern signal: an eye boundary test and an eye opening test. Since the eye boundary can be easily tested by using the normal mask template testing, this section mainly focuses on how to create the mask for testing the eye opening. A fail region in the shape of a hexagon is usually used to test the eye opening. An example of the shape of the mask is shown below.

**Figure 2-18**

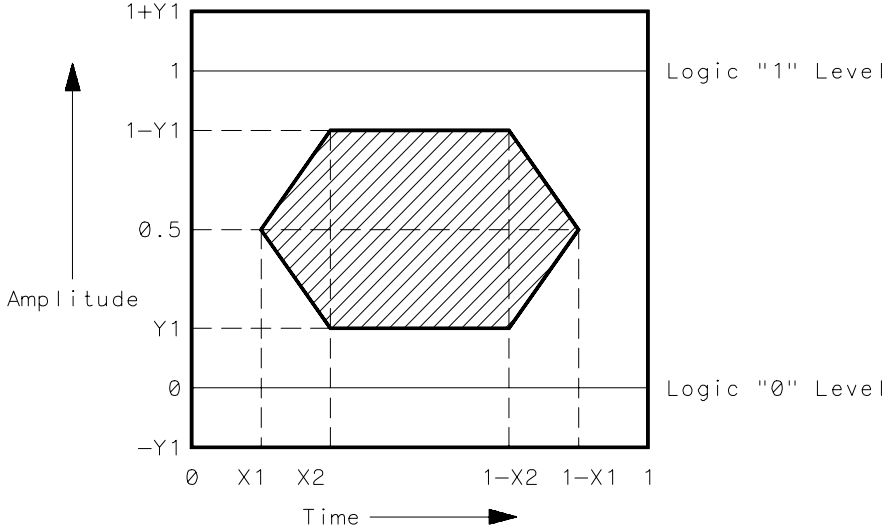

X1	X2	Y1
0.15	0.35	0.20

54600812

**Example of the definition of an eye-pattern testing mask**

- 1 Set up the oscilloscope for proper viewing of the eye-pattern signal.
- 2 Determine the fail region.
- 3 Create the mask using the line drawing capabilities of the mask editor.

The voltage and time readouts in the mask editor can be used to ensure the correct shape and position of the mask. An example of how the mask template looks during testing is shown below.

- 4 Select the fail region as Inside of the mask template.

Figure 2-19

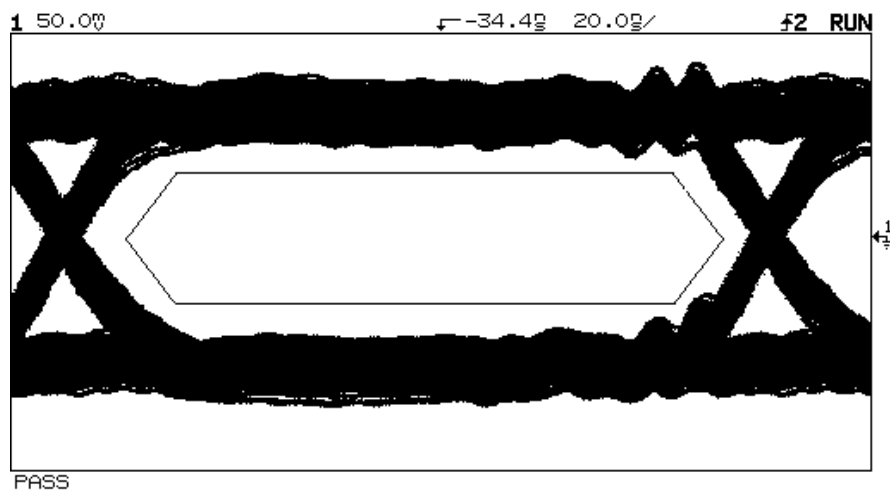

Example of a mask template used for eye-opening testing

---

## To save or recall traces

With the Measurement/Storage Module installed, the two volatile pixel memories are replaced with four high-speed non-volatile memories.

In addition, 64 Kbytes of nonvolatile trace memory with data compression is also provided. A data compression algorithm maximizes the number of traces and front-panel setups that can be stored into this memory.

The total number of traces that can be saved depends on the complexity of each trace. At least 4 highly complex traces, or up to 96 simple traces, can be saved in this 64 Kbytes of memory. Storage time is less than 10 seconds.

### 1 Adjust Oscilloscope controls for desired stable display.

### 2 Press Trace .

A softkey menu with six choices appears. All of them are related to the trace memories of the module.

- **Trace** Selects the trace memory (ALL, 1 to 100). When ALL is selected, four additional softkeys are displayed.
  - a **All Off** Used to turn all 100 trace memories to off.
  - b **All On** Used to turn all 100 trace memories to on.
  - c **Clear All** Used to clear the contents of all 100 trace memories at one time.
  - d **Review Traces** Used to view the contents of all trace memories (with stored data) one at a time. View time is approximately 3 seconds. When selected, two additional softkeys are displayed. **Pause Review** pauses review cycle on current trace until key is pressed again, and **Cancel Review** cancels the review cycle.
- **Trace X Off On** Turns the selected memory number to on or off. When on is selected, trace status is temporarily displayed on the screen.
- **Save to Trace X** Saves the currently displayed waveform and front-panel setup to the selected trace memory location.
- **Clear Trace X** Erases a previously stored waveform and front-panel setup from the selected trace memory location.

- **Recall Setup** Recalls the previously stored front-panel setup that was saved with the waveform for the trace selected.
  - **Edit Label** Used to enter a 20 character label that identifies the stored waveform. See "Create a Label for Trace Memory" later in this chapter for more information.
- 3 Turn the knob closest to the **Cursors** key to move the cursor in the character area to select the desired trace location (from 1 to 100).
- Trace status is displayed on the screen. Information includes the edit label (or trace number if label has not been entered), and the time and date the memory was saved or cleared.
- 4 Select the desired softkey (**Save**, **Clear**, or **Recall**).

#### **Saving Traces Hint**

For traces 1 to 3, the trace is saved in the non-compressed state. For traces greater than 3, the trace is saved in 64 Kbytes of nonvolatile trace memory with data compression. After a compressed trace is saved, the available area (in percent) is displayed.

The number of traces that can be saved in 64 Kbytes of nonvolatile trace memory is dependent on the trace complexity and the current oscilloscope configuration. For example:

Up to 97 simple traces (e.g., square wave) can be stored.

As few as four complex traces (AM modulated sine wave) can be stored.

Saving a trace with autostore information or the grid takes more memory. In most cases, if the information is not needed, turn it off to save memory.

The data compression algorithm uses run length encoding to compress the data. Where possible, runs of identical bits are stored as a single word (1 identification bit and 15 length bits).

The Review Traces feature is useful when observing test failures.

To store only the front-panel setup, blank the screen prior to saving the trace. The edit label function can be used to identify the setup.

## To create a label for a trace memory

Each trace stored in Measurement/Storage Module can have a label up to 20 characters long to identify the stored waveform.

**1** Press **Trace** .

**2** Press the **Edit Label** softkey.

A softkey menu with six softkey choices appears. Five of them are related to editing the message.

- **Enter** Enters the highlighted character in the character area into the message area under the cursor position.
- **Space** Enters a space in the message area under the cursor position.
- **Delete** Deletes the character in the message area under the cursor position.
- **Insert** Toggles the insert function on or off. With insert on, pressing Enter or Space inserts the character or space into the message before the character at the cursor position. The rest of the message is shifted to the right by one character. With insert off, pressing Enter or Space replaces the character highlighted in the character area.
- **Clear To End** Clears the characters from the cursor position to the end of the message including the one under the cursor.
- **Done** Exits the editing of the message.

**3** Turn the Delay knob to move the cursor in the label to the position that you want to edit.

**4** Turn the knob closest to the **Cursors** key to move the cursor in the character area to select the character that you want to enter.

**5** Press the **Enter** softkey to enter the highlighted character into the user message, or press the **Space** softkey to enter a space into the user message.

**6** Repeat procedures 3 through 5 until finished editing the message.  
The maximum length of the label is 20 characters.

**7** Press the **Done** softkey.

Your message is displayed when you execute the various trace functions.

---

## To set real-time clock

Time (24-hour format) and date tagging of hard copy and nonvolatile trace memories is provided using a built in, battery backed up real-time clock. To set time and date, or view current contents:

**1** Press **Print/Utility**.

**2** Press the **Set Clock** softkey.

**3** Press the **Set Time** softkey.

A softkey menu with five choices appears. Four of them are related to setting the real-time clock time.

- **Hour** Selects the hours digits (in 24 hour format). Current selection can be changed using the knob closest to the **Cursors** key, or by repeatedly pressing the softkey.
- **Minute** Selects the minutes digits. Current selection can be changed using the knob closest to the **Cursors** key, or by repeatedly pressing the softkey.
- **Second** Selects the seconds digits. Current selection can be changed using the knob closest to the **Cursors** key, or by repeatedly pressing the softkey.
- **Enter Time** Press to set the real-time clock time to the values displayed in the softkey area.
- **Previous Menu** Returns you to the previous softkey menu.

**To set real-time clock**

**4 Press the Set Date softkey.**

A softkey menu with six choices appears. Five of them are related to setting the real-time clock date.

- **Day** Selects the day. Current selection can be changed using the knob closest to the **Cursors** key, or by repeatedly pressing the softkey.
- **Month** Selects the month. Current selection can be changed using the knob closest to the **Cursors** key, or by repeatedly pressing the softkey.
- **Date** Selects the day of the month. Current selection can be changed using the knob closest to the **Cursors** key, or by repeatedly pressing the softkey.
- **Year** Selects the year. Current selection can be changed using the knob closest to the **Cursors** key, or by repeatedly pressing the softkey.
- **Enter Date** Press to set the real-time clock date to the values displayed in the softkey area.
- **Previous Menu** Returns you to the previous softkey menu.

**5 Press the Current Time/Date softkey to display current real-time clock time and date information.**

**Real-time Clock Hint**

The real-time clock only allows selection of valid dates. If a day is selected and the month or year is changed so the day is now invalid, the day is automatically adjusted (e.g. Feb 29).



---

Reference Information

---

## Reference Information

This chapter contains reference information for the Measurement/Storage Modules including its operating characteristics.

---

## Operating Characteristics

Operating Characteristics are specified with the Measurement/Storage Module installed on an HP 54600-Series Oscilloscope.

---

### Measurements

<b>Voltage</b>	Vamp, Vavg, Vrms, Vpp, Vpre, Vovr, Vtop, Vbase, Vmin & Vmax
<b>Time</b>	Delay, Duty Cycle, Frequency, Period, Phase Angle, Rise Time, Fall Time, +Width, & -Width
<b>Thresholds</b>	User-selectable among, 10%/90%, 20%/80% or voltage levels
<b>Cursor Readout</b>	Voltage, time, percentage, and phase angle.
<b>Waveform Math Functions</b>	Addition, subtraction, multiplication, differentiation, integration, and FFT.

---

### Fast Fourier Transforms

<b>Test Region</b>	Each pixel is selectable to be tested or not.
<b>Inputs</b>	On either ch1, ch2, or F1
<b>Freq Cursor Resolution</b>	From 1.22 mHz (milliHz) to 9.766 MHz (1.22 mHz to 48.828 MHz for HP 54615/54616)
<b>Points</b>	Fixed at 1024 for all models except HP 54615/54616 Fixed at 1024 for HP 54615/54616 with vectors off Fixed at 512 for HP 54615/54616 with vectors on
<b>Peak Find:</b>	Find Peak automatically snaps cursor to the two largest peaks located anywhere in the displayed frequency span. Measurement information is automatically displayed at the bottom of the screen together with the difference in frequency between the two selected peaks.
<b>Variable Sensitivity and Offset</b>	Sensitivity and vertical offset (position) are controlled from the front panel to display an optimum view of the spectrum. Sensitivity is calibrated in dB per divisions; vertical offset is calibrated in dBV.
<b>Time Record Length</b>	10x main sweep speed.
<b>Horizontal Magnification and Center Frequency Control</b>	As the frequency span is changed, the display is magnified about center frequency so that you get a closer view.

Reference Information  
**Operating Characteristics**

**Selectable Windows** Four windows are selectable: Hanning, for best frequency resolution and general purpose use; flattop, for best amplitude accuracy; rectangular, for single-shot signals such as transients and signals where there are an integral number of cycles in the time record, and exponential for best transient analysis.

**Window Characteristics**

Window	Highest Side Lobe (dB)	3dB Bandwidth(bins)	6dB Bandwidth(bins)	Scallop Loss (dB)
Rectangular	-13	0.89	1.21	3.92
Hanning	-32	1.44	2.00	1.42
Flattop	-70	3.38	4.17	0.005

**FFT Freq Range** dc to 100 MHz HP 54600/54601/54645  
 dc to 150 MHz HP54602  
 dc to 60 MHz HP54603  
 dc to 500 MHz HP54610/54615/54616

**Freq Span Control** This control allows you to specify the frequency span of the FFT display. When the Span is adjusted the display will expand or contract about the center frequency as set by the Center Frequency control. Refer to Figure 3-1 for the limits of the Frequency Span control.

**Center Freq Control** This control allows you to specify the frequency at the center of the FFT display. When the Frequency Span is changed, the FFT display will expand or contract about the frequency at the center of the display. Refer to Figure 3-1 for the limits of this control.

**Move 0 Hz to Left** Pressing this soft key will move the FFT display so that the left hand edge of the display will be 0Hz.

**FFT Vector display** When the time domain display is turned off the FFT display will be displayed in vector drawing mode. The time domain display can be turned off by pressing the Channel # key twice

**Display** FFT vertical units in dB.

**Units/Div** This control allows you to adjust the vertical scaling of the FFT display in a 1-2-5 sequence from 1 dB/div to 50 dB/div.

**Reference Level** This control allows adjustment of the reference level of the FFT display across a range of 400 dBV. The minimum setting is -196 dB at 1 dBV/div decreasing to 0 dBV at 50 dBV/div. The maximum setting is 400 dBV at 50 dB/div, decreasing to 204 dB at 1 dBV/div.

**Programmability** All front-panel controls are fully programmable over HP-IB (HP 54657A) or RS-232 (HP 54658A and HP 54659B)

Figure 3-1

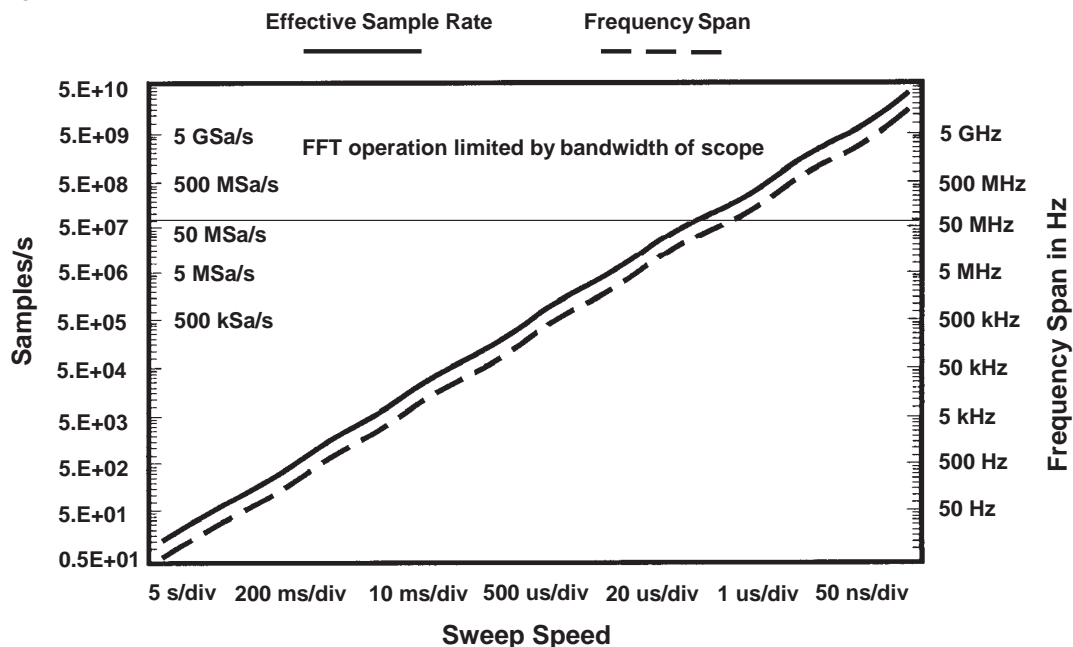

Sweep Speed	Effective Sample Rate	Maximum Frequency Span	Sweep Speed	Effective Sample Rate	Maximum Frequency Span
5 s/div	20 Hz	9.75 Hz	50 μs/div	2 MHz	975k kHz
2 s/div	50 Hz	24.4 Hz	20 μs/div	5 MHz	2.44 MHz
1 s/div	100 Hz	48.85 Hz	10 μs/div	10 MHz	4.885 MHz
500 ms/div	200 Hz	97.5 Hz	5 μs/div	20 MHz	9.75 MHz
200 ms/div	500 Hz	244 Hz	2 μs/div	50 MHz	24.4 MHz
100 ms/div	1 kHz	488.5 Hz	1 μs/div	100 MHz	48.85 MHz
50 ms/div	2 kHz	975 Hz	500 ns/div	200 MHz	97.5 MHz
20 ms/div	5 kHz	2.44 kHz	200 ns/div	500 MHz	244 MHz
10 ms/div	10 kHz	4.885 kHz	100 ns/div	1 GHz	488.5 MHz
5 ms/div	20 kHz	9.75k Hz	50 ns/div	2 GHz	975 MHz
2 ms/div	50 kHz	24.4 kHz	20 ns/div	5 GHz	2.44 GHz
1 ms/div	100 kHz	48.85 kHz	10 ns/div	10 GHz	4.885 GHz
500 μs/div	200 kHz	97.5 kHz	5 ns/div	20 GHz	9.75 GHz
200 μs/div	500 kHz	244 kHz	2 ns/div*	50 GHz	24.41 GHz
100 μs/div	1 MHz	488.5 kHz			

\* 2 ns/div FFT valid only on HP 54615/54616

FFT Operation  
Frequency Span and Effective Sampling Rate vs Sweep Speed

Reference Information  
**Operating Characteristics**

---

**Mask Template Testing**

---

<b>Number of mask templates</b>	2, nonvolatile
<b>Mask template generation</b>	Automask generates a mask from waveform data with variable tolerances.  Mask editor allows pixel-by-pixel editing and line drawing editing. Smooth mask function performs a running average of 3 pixels.
<b>Test Region</b>	Each pixel is selectable to be tested or not
<b>Fail Region</b>	Inside-signal fails if it falls inside the region bounded by the maximum and minimum limit lines.  Outside-signal fails if it falls outside the region bounded by the maximum and minimum limit lines.
<b>Failure indication</b>	Failure zone indicator shows where the signal fails the mask template.
<b>Failure mode</b>	Failure modes are stop or continue on failure. Failure(s) can be saved to trace memory or printed

---

**Trace Memory (all nonvolatile)**

---

<b>1 through 3</b>	High-speed storage without compression.
<b>4 through 100</b>	Storage with compression, number of traces is a function of complexity. Storage time is less than 10 seconds.

---

**Real Time Clock**

---

<b>Can be set from front panel.</b>	24-hour format with battery back-up.
-------------------------------------	--------------------------------------

---

**Hardcopy Output**

---

<b>Printer/Plotter Supported</b>	HP ThinkJet, HP QuietJet, HP PaintJet, HP DeskJet, and HP LaserJet printer. HP-GL compatible plotters.
<b>HP 54658A and HP 54659B only</b>	Epson FX-80 or compatible printer.

---

**RS-232 Configurations**

---

<b>Connector Type</b>	With the adapter cable connected, at the end of the cable is a 9 pin/25 pin DTE port; a printer cable is required to connect it to hardcopy devices or a computer.
<b>Protocols</b>	XON/XOFF, hardware.
<b>Data Bits</b>	8
<b>Stop Bits</b>	1
<b>Parity:</b>	none.
<b>Baud Rates</b>	1200, 2400, 9600, 19200.

---

**Programmability**

---

All instrument settings and operating modes may be remotely programmed via RS-232 and HP-IB (IEEE-488).





---

# Index

---

## I

∫dt, 2-5

## A

aliasing, 2-9  
Automask, 2-30  
automatic measurements, 2-14  
  delay, 2-19  
  phase, 2-21  
  Vamplitude, 2-23  
  voltage, 2-23  
  Vovershoot, 2-23  
  Vpreshoot, 2-23  
Autostore, 2-31

## C

cable, 1-4  
  HP-IB, 1-4  
  parallel, 1-4  
  RS-232, 1-4, 1-6 to 1-7  
center frequency, 2-11  
clock, set, 2-55  
compatibility, 1-2  
configure module, 1-4  
connector  
  DB25, 1-5  
  DB9, 1-7  
create a mask  
  Automask, 2-30  
  Autostore, 2-31  
  delay, 2-42  
  eye-pattern, 2-50  
  frequency, 2-44  
  line segments, 2-33  
  overshoot, 2-46  
  rise time, 2-48  
create a trace memory label, 2-54  
cursor measurements, 2-25  
  time (degrees), 2-26  
  voltage (percent), 2-25

## D

DB25 connector, 1-5  
DB9 connector, 1-7  
dBm, 2-8  
DC Value, 2-8  
delay measurements, 2-19  
delay testing mask, 2-42  
differentiate, 2-5  
dV/dt, 2-5

## E

edit a mask  
  line segments, 2-33  
  pixel, 2-35  
  waveform portion, 2-36  
exponential window, 2-11  
eye-pattern testing mask, 2-50

## F

FFT, 2-6, 2-8  
  aliasing, 2-9  
  center frequency, 2-11  
  DC Value, 2-8  
  Find Peaks, 2-11  
  frequency span, 2-11  
  measurement, 2-8  
  measurement hints, 2-12  
  Move 0Hz To Left, 2-11  
  Move f1 To Center, 2-11  
  operating characteristics, 3-3  
  operation, 2-10  
  spectral leakage, 2-10  
  window, 2-11  
Find Peaks, 2-11  
flattop window, 2-11  
frequency span, 2-11  
frequency testing mask, 2-44  
Function 1, 2-4  
Function 2, 2-5

## H

hanning window, 2-11  
hardcopy output, operating  
  characteristics, 3-6  
HP-IB  
  cable, 1-4

## I

installation, 1-3  
integrate, 2-5  
interface cables, 1-4

## L

label, trace memory, 2-54  
leakage, spectral, 2-10  
line segments, 2-33  
Lissajous, 2-21

## M

mask template testing, characteristics, 3-6  
mask, creating  
  eye-pattern, 2-50  
  frequency, 2-44  
  overshoot, 2-46  
  rise time, 2-48  
mask, editing  
  line segments, 2-33  
  pixel, 2-35  
  waveform portion, 2-36  
math functions, 2-3  
measurements, automatic, 2-14  
  delay, 2-19  
  phase, 2-21  
  Vamplitude, 2-23  
  voltage, 2-23  
  Vovershoot, 2-23  
  Vpreshoot, 2-23  
measurements, cursor, 2-25  
measurements, operating characteristics,  
  3-3  
minus (-), 2-4  
monitoring, waveform, 2-29  
Move 0Hz To Left, 2-11  
Move f1 To Center, 2-11  
multiply, 2-4

---

## N

Nyquist frequency, 2-9

## O

operating characteristics, 3-3

FFT, 3-3

hardcopy output, 3-6

mask template testing, 3-6

measurements, 3-3

programmability, 3-7

real-time clock, 3-6

RS-232 configurations, 3-7

trace memory, 3-6

operating system, 1-2

oscilloscope compatibility, 1-2

overshoot testing mask, 2-46

## P

parallel cable, 1-4

phase measurements, 2-21

phase shift, 2-21

pixel editing, 2-35

plus (+), 2-4

programmability, operating characteristics,  
3-7

## R

real time clock, operating characteristics,  
3-6

real-time clock, set, 2-55

recall traces, 2-52

rectangular window, 2-11

rise time testing mask, 2-48

RS-232

cable, 1-4, 1-6 to 1-7

configurations, characteristics, 3-7

port, 1-5, 1-7

## S

save traces, 2-52

saving test violations, 2-40

set real-time clock, 2-55

setting thresholds, 2-15

spectral leakage, 2-10

subtract, 2-4

## T

test violations, saving, 2-40

testing mask, creating

delay, 2-42

eye-pattern, 2-50

frequency, 2-44

overshoot, 2-46

rise time, 2-48

thresholds, 2-15

time cursor measurements, 2-26

trace memory label, 2-54

trace memory, operating characteristics,  
3-6

traces

non-volatile memories, 2-52

recall, 2-52

save, 2-52

## U

unattended waveform monitoring, 2-29

upgrade kit, 1-2

## V

Vamplitude, 2-23

voltage cursor measurements, 2-25

voltage measurements, 2-23

Vovershoot, 2-23

Vpreshoot, 2-23

## W

waveform mask edit, 2-36

waveform monitoring, 2-29

starting, 2-38

test violations, 2-40

window

exponential, 2-11

FFT, 2-11

flattop, 2-11

hanning, 2-11

rectangular, 2-11

© Copyright Hewlett-Packard Company 1992-1996  
All Rights Reserved.

Reproduction, adaptation, or translation without prior written permission is prohibited, except as allowed under the copyright laws.

### Document Warranty

The information contained in this document is subject to change without notice.

**Hewlett-Packard makes no warranty of any kind with regard to this material, including, but not limited to, the implied warranties of merchantability or fitness for a particular purpose.**

Hewlett-Packard shall not be liable for errors contained herein or for damages in connection with the furnishing, performance, or use of this material.

### Safety

This apparatus has been designed and tested in accordance with IEC Publication 348, Safety Requirements for Measuring Apparatus, and has been supplied in a safe condition. This is a Safety Class I instrument (provided with terminal for protective earthing). Before applying power, verify that the correct safety precautions are taken (see the following warnings). In addition, note the external markings on the instrument that are described under "Safety Symbols."

### Warning

- Before turning on the instrument, you must connect the protective earth terminal of the instrument to the protective conductor of the (mains) power cord. The mains plug shall only be inserted in a socket outlet provided with a protective earth contact. You must not negate the protective action by using an extension cord (power cable) without a protective conductor (grounding). Grounding one conductor of a two-conductor outlet is not sufficient protection.
- Only fuses with the required rated current, voltage, and specified type (normal blow, time delay, etc.) should be used. Do not use repaired fuses or short-circuited fuseholders. To do so could cause a shock or fire hazard.

- Service instructions are for trained service personnel. To avoid dangerous electric shock, do not perform any service unless qualified to do so. Do not attempt internal service or adjustment unless another person, capable of rendering first aid and resuscitation, is present.

- If you energize this instrument by an auto transformer (for voltage reduction), make sure the common terminal is connected to the earth terminal of the power source.

- Whenever it is likely that the ground protection is impaired, you must make the instrument inoperative and secure it against any unintended operation.

- Do not operate the instrument in the presence of flammable gasses or fumes. Operation of any electrical instrument in such an environment constitutes a definite safety hazard.

- Do not install substitute parts or perform any unauthorized modification to the instrument.

- Capacitors inside the instrument may retain a charge even if the instrument is disconnected from its source of supply.

- Use caution when exposing or handling the CRT. Handling or replacing the CRT shall be done only by qualified maintenance personnel.

### Safety Symbols



Instruction manual symbol: the product is marked with this symbol when it is necessary for you to refer to the instruction manual in order to protect against damage to the product.



Hazardous voltage symbol.



Earth terminal symbol: Used to indicate a circuit common connected to grounded chassis.

### WARNING

The Warning sign denotes a hazard. It calls attention to a procedure, practice, or the like, which, if not correctly performed or adhered to, could result in personal injury. Do not proceed beyond a Warning sign until the indicated conditions are fully understood and met.

### CAUTION

The Caution sign denotes a hazard. It calls attention to an operating procedure, practice, or the like, which, if not correctly performed or adhered to, could result in damage to or destruction of part or all of the product. Do not proceed beyond a Caution symbol until the indicated conditions are fully understood or met.

---

## Product Warranty

This Hewlett-Packard product has a warranty against defects in material and workmanship for a period of three years from date of shipment. During the warranty period, Hewlett-Packard Company will, at its option, either repair or replace products that prove to be defective. For warranty service or repair, this product must be returned to a service facility designated by Hewlett-Packard.

For products returned to Hewlett-Packard for warranty service, the Buyer shall prepay shipping charges to Hewlett-Packard and Hewlett-Packard shall pay shipping charges to return the product to the Buyer. However, the Buyer shall pay all shipping charges, duties, and taxes for products returned to Hewlett-Packard from another country.

Hewlett-Packard warrants that its software and firmware designated by Hewlett-Packard for use with an instrument will execute its programming instructions when properly installed on that instrument. Hewlett-Packard does not warrant that the operation of the instrument software, or firmware will be uninterrupted or error free.

## Limitation of Warranty

The foregoing warranty shall not apply to defects resulting from improper or inadequate maintenance by the Buyer, Buyer-supplied software or interfacing, unauthorized modification or misuse, operation outside of the environmental specifications for the product, or improper site preparation or maintenance.

**No other warranty is expressed or implied. Hewlett-Packard specifically disclaims the implied warranties of merchantability or fitness for a particular purpose.**

## Exclusive Remedies

The remedies provided herein are the buyer's sole and exclusive remedies. Hewlett-Packard shall not be liable for any direct, indirect, special, incidental, or consequential damages, whether based on contract, tort, or any other legal theory.

## Assistance

Product maintenance agreements and other customer assistance agreements are available for Hewlett-Packard products.

For any assistance, contact your nearest Hewlett-Packard Sales Office.

## Certification

Hewlett-Packard Company certifies that this product met its published specifications at the time of shipment from the factory. Hewlett-Packard further certifies that its calibration measurements are traceable to the United States National Institute of Standards and Technology, to the extent allowed by the Institute's calibration facility, and to the calibration facilities of other International Standards Organization members.

## About this edition

This is the first edition of the *HP 54657A, HP 54658A, and HP 54659B Measurement/Storage Modules User's Guide*.

Publication number  
54657-97010

Printed in USA.

Edition dates are as follows:  
First edition, October 1996

New editions are complete revisions of the manual. Update packages, which are issued between editions, contain additional and replacement pages to be merged into the manual by you. The dates on the title page change only when a new edition is published.

A software or firmware code may be printed before the date. This code indicates the version level of the software or firmware of this product at the time the manual or update was issued. Many product updates do not require manual changes; and, conversely, manual corrections may be done without accompanying product changes. Therefore, do not expect a one-to-one correspondence between product updates and manual updates.

The following list of pages gives the date of the current edition and of any changed pages to that edition.

All pages original edition

# DECLARATION OF CONFORMITY

according to ISO/IEC Guide 22 and EN 45014

**Manufacturer's Name:** Hewlett-Packard Company

**Manufacturer's Address:** Colorado Springs Division  
1900 Garden of the Gods Road  
Colorado Springs, CO 80907 USA

declares, that the product

**Product Name:** Digitizing Oscilloscope

**Model Number(s):** HP 54657A, HP 54658A, and HP 54659B

**Product Option(s):** All

conforms to the following Product Specifications:

**Safety:** IEC 1010-1:1990+A1 / EN 61010-1:1993  
UL 3111  
CSA-C22.2 No. 1010.1:1993

**EMC:** CISPR 11:1990 / EN 55011:1991 Group 1 Class A  
IEC 555-2:1982 + A1:1985 / EN 60555-2:1987  
IEC 555-3:1982 + A1:1990 / EN 60555-3:1987 + A1:1991  
IEC 801-2:1991 / EN 50082-1:1992 4 kV CD, 8 kV AD  
IEC 801-3:1984 / EN 50082-1:1992 3 V/m, {1kHz 80% AM, 27-1000 MHz}  
IEC 801-4:1988 / EN 50082-1:1992 0.5 kV Sig. Lines, 1 kV Power Lines

## Supplementary Information:

The product herewith complies with the requirements of the Low Voltage Directive 73/23/EEC and the EMC Directive 89/336/EEC and carries the CE marking accordingly.

This product was tested in a typical configuration with Hewlett-Packard test systems.

Colorado Springs, 01/12/95

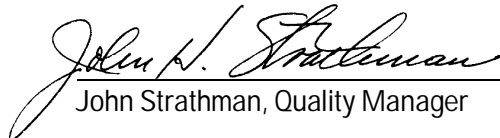
  
John Strathman, Quality Manager

European Contact: Your local Hewlett-Packard Sales and Service Office or Hewlett-Packard GmbH, Department ZQ / Standards Europe, Herrenberger Strasse 130, D-71034 Böblingen Germany (FAX: +49-7031-14-3143)

## Product Regulations

**Safety** IEC 1010-1:1990+A1 / EN 61010-1:1993  
UL 3111  
CSA-C22.2 No.1010.1:1993

**EMC** This Product meets the requirement of the European Communities (EC)  
EMC Directive 89/336/EEC.



**Emissions** EN55011/CISPR 11 (ISM, Group 1, Class A equipment)

<b>Immunity</b>	EN50082-1	Code <sup>1</sup>	Notes <sup>2</sup>
	IEC 555-2	1	
	IEC 555-3	1	
	IEC 801-2 (ESD) 4kV CD, 8kV AD	1,2	*
	IEC 801-3 (Rad.) 3 V/m	2	
	IEC 801-4 (EFT) 0.5 kV, 1kV	1,2	*

<sup>1</sup> Performance Codes:

- 1 PASS - Normal operation, no effect.
- 2 PASS - Temporary degradation, self recoverable.
- 3 PASS - Temporary degradation, operator intervention required.
- 4 FAIL - Not recoverable, component damage.

<sup>2</sup> Notes:

- \* Code 1 for HP 54616C
- Code 2 for HP 54615B and HP 54616B

**Sound Pressure Level** Less than 60 dBA

Press this key ...

... to obtain this menu

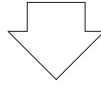
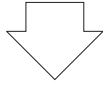

**Voltage**

Voltage Measurements V pre

V amp V over

Next Menu

**Time**

Define Thresholds Define Delay Measure Delay Phase

Next Menu

Define Thresholds

10% 90% Thresholds 20% 80% Voltage Lower 500.0mV Upper 2.000 V Previous Menu

Define Delay

Chan 1 : Edge Chan 2 : Edge

Previous Menu

**Cursors**

Source Active Cursor

Clear Cursors

Source V1... V2--

Source Active Cursor Readout Set Clear

Volts 100% Cursors

Source t1! t2!

Source Active Cursor Readout Set Clear

Time Deg 360° Cursors

Source

Source Active Cursor Find Peaks Move f1 Clear

f1! f2! To Center Cursors





Press this key ...

... to obtain this menu

